

OCTALARM[®]-T2
OCTALARM[®]-T4
OCTALARM[®]-T8
OCTALARM[®]-T16

ENGLISH

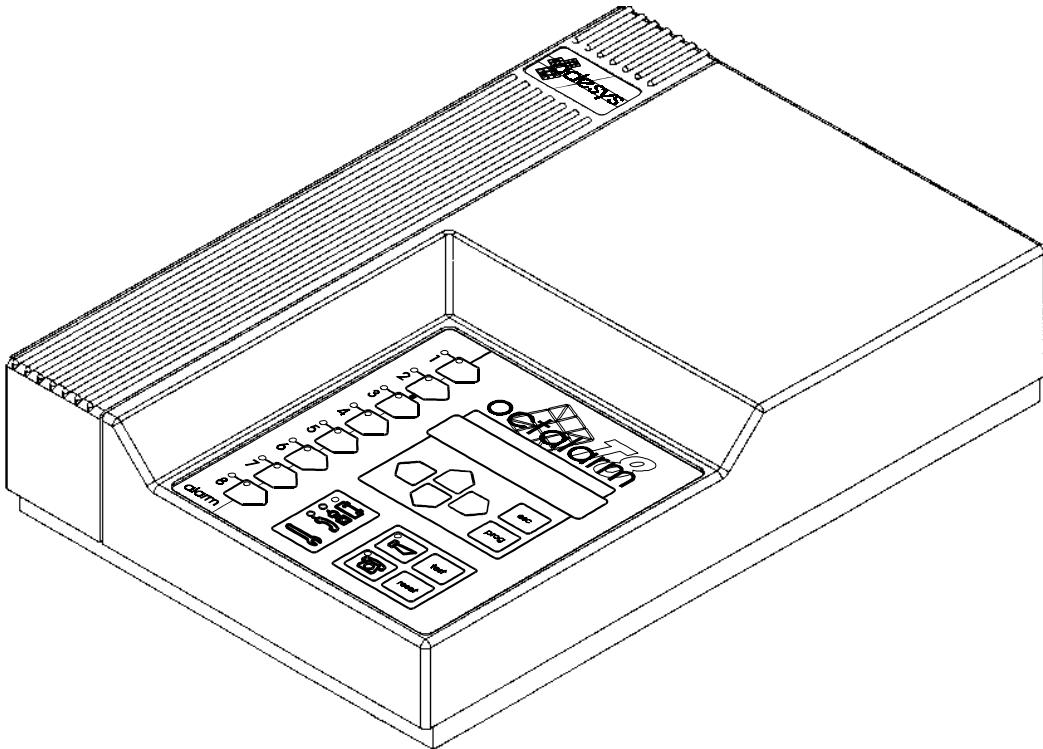

Octalarm is a registered trademark
From Adesys bv, Wateringen, NL



Edition 16-08-2002

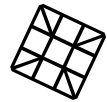

General	4
1. INTRODUCTION	4
1.1 Used pictograms	5
2. DELIVERY CHECK	5
2.1 Environment	5
3. GUARANTEE AND LIABILITY	6
Operation instructions	7
4. FUNCTIONING OF TELEPHONE ALARM	7
4.1 Alarm procedure	8
4.2 Dialling order	8
4.3 Alarm channels and report codes	8
4.3.1 Report to telephone	8
4.3.2 Report to pager	9
4.3.3 Report to mobile telephone	9
4.3.4 Report to reporting services	9
4.4 Reset procedure	10
4.5 More than one alarm simultaneously	10
4.5.1 Reporting channels with a default dialler	10
4.5.2 Reporting channels with a deviant dialler	10
4.5.3 Combination of a default/custom dialler	10
5. FUNCTIONING OF THE LOCAL ALERT	11
5.1 Alarm buzzers	11
5.2 Flashlight	11
6. OPERATION	12
6.1 Alarm indicators	12
6.2 Alarm channel selection keys	12
6.3 Device malfunction indicators	12
6.4 Reset key	13
6.5 Test key	13
6.6 Buzzer key	13
6.7 Telephone dialler key	13
6.8 Display and cursor keys	13
6.9 Prog-key	14
6.10 Esc-key	14
7. SET CALL NUMBERS	15
7.1 Report to a telephone	15
7.2 Report to a pager	16
7.2.1 Characteristics of a tone-only pager	16
7.2.2 Characteristics of an (alpha) numerical pager	16
7.3 Report to a mobile telephone	17
7.4 Report to a reporting service	17
7.5 Set reset procedure	17
7.5.1 Reset during call	18
7.5.2 Reset by the service	18
7.5.3 Reset by calling back	18
8. CALL BACK TO RESET AN ALARM	19
8.1 Reset without using a reset code	19
8.2 Reset using a reset code	19
9. RETRIEVE ALARM STATUS BY TELEPHONE	20
10. SWITCHING THE RELAY OUTPUT BY TELEPHONE	20
11. NIGHT TIME MODE	21
12. MAINS FAILURE	22
12.1 Mains failure report	22
12.2 Battery empty report	22
12.3 Back up supply	22
12.4 Automatic battery test	22
13. TESTING	23
13.1 Optic and acoustic alarms test	23
13.2 Telephone report test	23

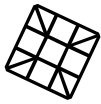

14.	SWITCH OFF COMPLETELY	23
15.	ERROR MESSAGES	24
Installation instruction		25
16.	INSTALLATION	25
16.1	Placement	25
16.2	Connection diagram	25
16.3	Connection of inputs	26
16.3.1	Alarm inputs	26
16.3.1.1	Direct connection	26
16.3.1.2	Connection through Sensornet	27
16.3.2	Input night time mode	27
16.3.3	Input external reset contact	28
16.4	Connection of outputs	28
16.4.1	Output external signal light	28
16.4.2	External buzzer outputs	28
16.4.3	External relay output	28
16.5	Connection of the telephone line	28
16.5.1	ISDN telephone connection	30
16.5.1.1	General guidelines for ISDN	32
16.6	Placing and connecting the GSM antenna	32
16.6.1	Internal antenna	32
16.6.2	External antenna	32
16.7	Placing the SIM card	32
16.8	Connecting the COM port	33
17.	PROGRAMMING OF INSTALLATION DATA	34
17.1	Programming options	34
17.1.1	Programming using the operation panel	34
17.1.2	Programming using the PC	34
17.1.3	Programming using a telephone line	35
17.1.3.1	Analogue or ISDN model	35
17.1.3.2	GSM model	35
18.	INSTALLATION PROGRAMS	36
18.1	Prog 10 "set display contrast"	36
18.2	Prog 11 "show version number"	36
18.3	Prog 21 "set alarm inputs"	36
18.4	Prog 23 "set alarm on display"	37
18.5	Prog 31 "set alarm buzzer"	37
18.6	Prog 41 "set dialler"	38
18.6.1	Octalarm for PSTN (analogue network)	38
18.6.2	Octalarm for ISDN (digital network)	38
18.6.3	Octalarm for GSM (mobile communication network)	40
18.7	Prog 42 "set dial sequence"	41
18.8	Prog 55 "set pager codes"	43
18.8.1	Set report codes tone-only pager	43
18.8.2	Set report codes numerical pager	43
18.8.3	Set codes of alpha-numerical pager and SMS-messages	44
18.9	Prog 59 "record voice messages"	44
18.10	Prog 61 "set access code"	44
18.11	Prog 71 "set night time mode"	45
18.12	Prog 95 "sensor test"	46
18.13	Prog 97 "read data log"	47
18.14	Prog 98 "choose language"	48
18.15	Prog 99 "clear all settings"	48
19.	TECHNICAL SPECIFICATIONS	49
Settings summary		50

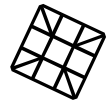

1. INTRODUCTION

The Octalarm is an alarm system that signals and reports technical failures and calamities by telephone, of both manned and unmanned installations and processes.

Alarms can be put through to fixed telephones, mobile telephones, radiotelephones, switchboards or combination of these, using an analogue ISDN telephone connection (model -I) or a mobile 900 or 1800Mhz network (model -G). There are various optical and acoustic signal options for local alarm systems.

The Octalarm-T2, -T4, -T8 and -T16 are equipped with respectively 2, 4, 8 or 16 alarm channels. A telephone report takes place by means of a recognizable tone code or a self-recorded voice message. The codes for reporting to a pager can be set freely, just like the desired dialling order and the reset procedures.

The alarm status of the guarded object can be retrieved from each Octalarm using the telephone line.

Furthermore, the Octalarm disposes of:

- user-definable delay times
- user-definable start and stop conditions for local alert
- display of alarm cause
- built-in emergency power supply
- mains supply guard
- guard of battery performance
- telephone line test
- flashlight output
- remote control output
- night time mode
- data log
- Sensonet connection (only for versions T4, T8 and T16)
- access protection
- extensive test facilities
- RS-232 connection
- permanent memory for all settings and report texts.

Operation and configuration are menu-driven. They take place using the control panel, via a directly connected PC, or by telephone line using the built-in modem.

After connecting, a number of fixed installation parameters have to be set on the Octalarm. As they are of a technical nature and since technical knowledge of, e.g. the connected alarm devices is assumed, we recommend leaving the entry of this data to the installer. Therefore, this manual is divided into:

- A **general** part for the user and the installer.
- **Operation instructions** for the user containing all items concerning the configuration and operation by the user.
- **Installation instructions** for the installer containing all items concerning the connecting of the Octalarm and the programming of the installation data.
- A **settings summary** for both the user and the installer.

 We advise you to read this manual carefully, so that you can take optimal advantage of all the application possibilities of the Octalarm.

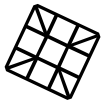

1.1 Used pictograms

This manual makes use of a couple of pictograms. They have the following meanings:



Hint or point of special interest



Action to be performed

2. DELIVERY CHECK

Check the packing for damages. In case the delivery seems to be damaged or incomplete on reception, please contact your supplier immediately.

The delivery includes:

- Octalarm
- protective cover for the connections
- connecting cables:
 - analogue execution: telephone wire with country-dependent telecom plug,
 - ISDN model: ISDN cable,
 - GSM-execution: none.
- this manual
- guarantee card.

You can check the Octalarm's model number by pressing the test button after having switched it on. . The display will show the message `OCTALARMTEST-` followed by the model number (OT2, OT4, OT8 or OT16), followed by:

- -S: model with voice messages instead of tone code messages,
- -I : model for the ISDN network,
- -G: model for the mobile GSM network,
- or a combination of the above.

After connecting it to a wall socket, the Octalarm switches on automatically. You can switch it off by disconnecting the plug from the wall socket and by keeping the reset key depressed for some time.

2.1 Environment

This product contains a lead battery. For the sake of the environment, do not dispose of the product with the household refuse when you have to replace it at the end of its life span. You can hand in the device to your supplier or to a depot intended for this purpose.

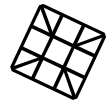

3. GUARANTEE AND LIABILITY

ADESYS puts every Octalarm through a series of extensive tests and an endurance test before shipping. Therefore, ADESYS offers a two years term of guarantee, on condition that the guarantee card is completed and returned upon taking into operation. The guarantee claim expires when:

- the malfunction is caused by gross negligence or by incompetent installation,
- the device has been repaired and/or altered without permission of ADESYS,
- the serial number on the device is removed or damaged.

ADESYS rejects any liability for consequential damage caused by incompetent use of, and/or malfunctions of the Octalarm.

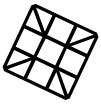

4. FUNCTIONING OF TELEPHONE ALARM

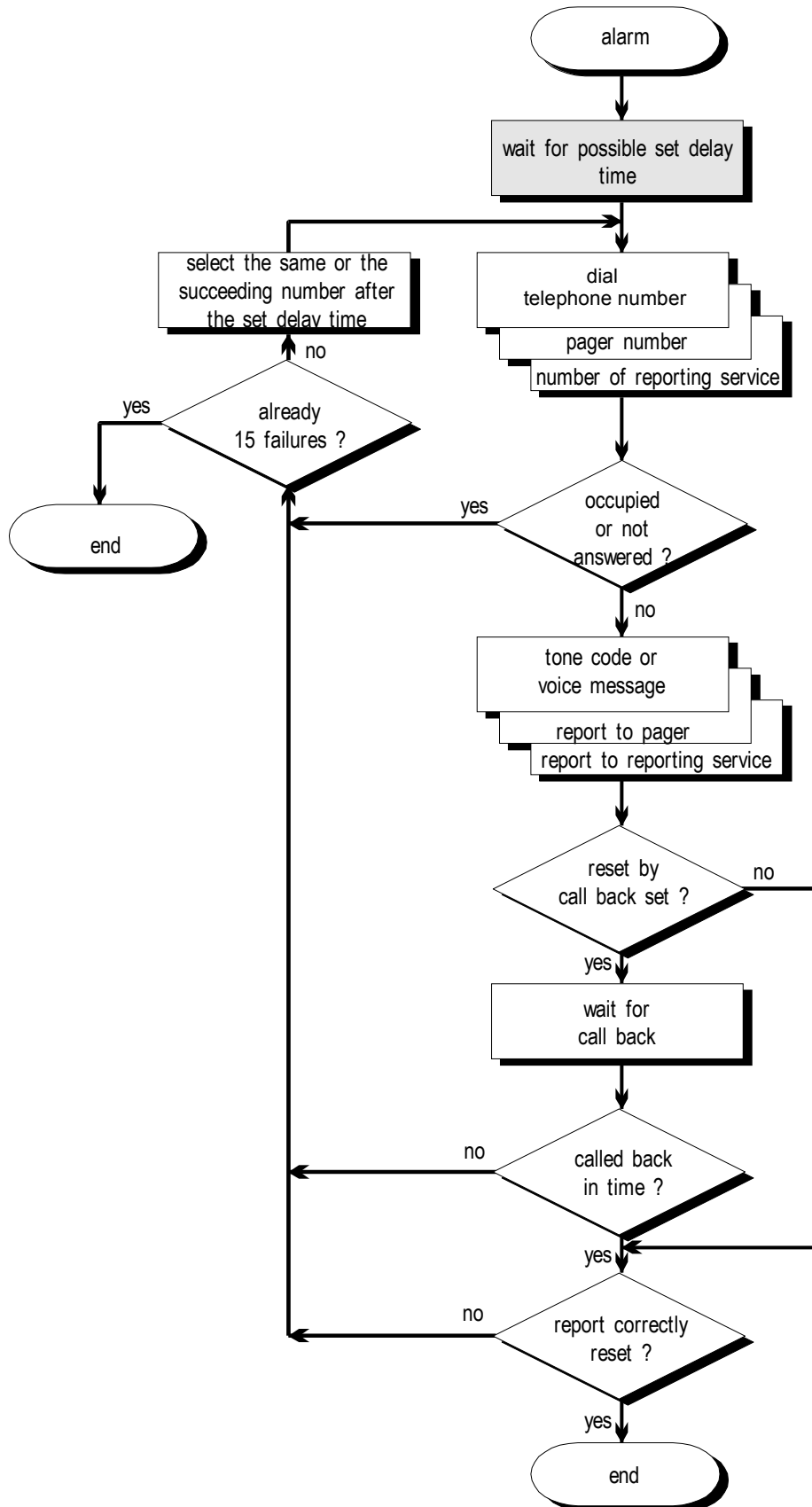

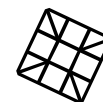

4.1 Alarm procedure

The telephone alarm procedure diagram shows what happens in case an alarm channel is activated using the factory defaults. Navigate through the diagram in the direction of the arrows, starting at the ALARM block.

 The function of the shaded block is by standard switched off. It can be activated by the installer using the installation program.

4.2 Dialling order

When the Octalarm fails to report successfully, it will start a new dialling attempt to the subsequent set number. The Octalarm considers a report unsuccessful if:

- the dialling attempt has failed, e.g. if there is no dialling tone or the busy signal is received during dialling,
- the person being called does not answer the call,
- the reset procedure is not accomplished correctly.

Using the factory defaults, all numbers entered (A through J) are passed in alphabetical order, whereby blank numbers are skipped automatically. When for example four numbers are entered, these numbers will be dialled alternately until the reset procedure is properly accomplished. After 15 unsuccessful attempts, the Octalarm will reset itself.

It is possible to set a specific dialling order for each alarm channel. This alteration has to be carried out in the installation program. See paragraph 18.7 Prog 42 "set dial sequence".

 Alterations of dialling order have to be carried out carefully, because it might happen that an alarm will no longer be reported due to a wrong setting!

4.3 Alarm channels and report codes

The Octalarm disposes of respectively 2, 4, 8 or 16 externally activated alarm channels and two internal channels: "mains failure" and "battery empty". An individual message is assigned to each channel.

4.3.1 Report to telephone

In case of a telephone report, an individual self-recorded voice message (for version -S) or a recognizable tone code will be reproduced for each channel.

The tone codes are pre-set and sound for the Octalarm –T2, -T4 and –T8 as follows:

- alarm channels 1 to 8: respectively 1 to 8 beeps
- mains failure: 9 beeps
- battery failure: 10 beeps.

The tone-codes for the Octalarm –T16 sound as follows:

- alarm channels 1 to 16: respectively 1 to 16 beeps
- mains failure: 17 beeps
- battery failure: 18 beeps.
-

The messages (for version -S) can be recorded using the installation program.

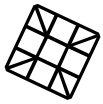

4.3.2 Report to pager

The following report codes are programmed for a report to pagers:

channel	tone-only pagers	numerical pagers	alpha-numerical pagers and SMS-messages
alarm 1	1	1	alarm 1
alarm 2	2	2	alarm 2
alarm 3	3	3	alarm 3
alarm 4	4	4	alarm 4
alarm 5	1	5	alarm 5
alarm 6	2	6	alarm 6
alarm 7	3	7	alarm 7
alarm 8	4	8	alarm 8
alarm 9	1	9	alarm 9
alarm 10	2	10	alarm 10
alarm 11	3	11	alarm 11
alarm 12	4	12	alarm 12
alarm 13	1	13	alarm 13
alarm 14	2	14	alarm 14
alarm 15	3	15	alarm 15
alarm 16	4	16	alarm 16
mains failure	4	9 or 90 (Octalarm-T16)	mains failure
battery empty	4	10 or 91 (Octalarm-T16)	battery empty / failure

With the Octalarm-T16, each alphanumeric radio telephone message and each SMS message is also preceded by an opening message of your choosing.

If required, all codes can be altered using the installation program 55.

4.3.3 Report to mobile telephone

The Octalarm can report to mobile telephones in two different ways:

- by means of a pre-set tone code or by a self-recorded voice message (version -S), as with a normal telephone,
- by using the Short-Message-Service (SMS), whereby the device's display is used as a pager. The report messages used for this purpose are equal to those of an alpha-numerical pager.

 Take account of the receiving range of your mobile telephone.

 Sometimes, depending on the degree of capacity-use of the mobile network, messages by SMS are passed with some delay. Therefore, it is recommendable to have time critical messages acknowledged by call back (see paragraph 4.4 "Reset procedure") and to have a second call number dialled in case there is no response in time.

4.3.4 Report to reporting services

The Octalarm uses the report codes for alpha-numerical pagers to report to the Adesys reporting centre. For reports to other centres, please contact your supplier.

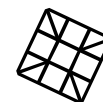

4.4 Reset procedure

The Octalarm has two ways of resetting a telephone report:

- Reset during the report. In case of reports to a pager, a reporting service or a mobile telephone with SMS, the reception of the acceptance tone is sufficient to reset the Octalarm. In case of telephone reports, a 4-digit reset code has to be entered during the report, using a tone dialling telephone.
- Reset by call back. Using this setting, the Octalarm has to be called back to acknowledge the reception of the report. The call back time limit is adjustable, as is the reset code (for optional use).

All settings mentioned above are adjustable for each individual call number.

4.5 More than one alarm simultaneously

The transaction order of alarms occurring simultaneously depends on whether a deviant dialling order has been set for the alarm channels concerned or not. (See configuration in the installation program Prog 42 "set dial sequence").

4.5.1 Reporting channels with a default dialler

No specific call numbers are selected for these reporting channels. The report attempts can be sent to each of the numbers entered (factory default).

In case more than one alarm takes place at the same time, the alerts will be passed on in groups as much as possible. With telephone reports, more than one alarm is heard at the same time and in case of a report to a pager or a reporting service, the report codes are passed on immediately after each other. In this way, the alarms are reported quickly and they can be reset simultaneously.

4.5.2 Reporting channels with a deviant dialler

A selection from the call numbers entered has been made for these reporting channels. The report attempts are only allowed to be sent to a limited number of call numbers, according to a determined order.

If these reporting channels are activated simultaneously, the Octalarm functions according to the priority principles, whereby the alarm with the highest priority precedes the other alarms. An alarm having a lower priority will only be reported after a telephone reset of the alarm with the highest priority, or following 15 unsuccessful report attempts. The priority of the reporting channels is determined as follows:

- battery empty channel,
- alarm channel 1,
- alarm channel 2, etc.
- mains failure channel.

If a channel with a higher priority is activated during a report, the running report will be interrupted and the highest priority alarm will be reported. After completing this alert, the report of the channel with a lower priority is resumed.

4.5.3 Combination of a default/custom dialler

Reporting channels with a different dialling order always have a higher priority to channels with a default dialling order.

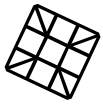

5. FUNCTIONING OF THE LOCAL ALERT

5.1 Alarm buzzers

In case of an alarm, the built-in buzzer will ring together with the buzzer(s) that may have been connected externally. The conditions that enable and disable the buzzer can be set:

- Enable immediately after detection of the alarm (factory default).
- Enable after a set delay time.
- Only enable if a telephone report has failed completely.
- Disable automatically after a set delay time or at the moment the reset key is pressed.
- Disable when the telephone report has passed off correctly (factory default).
- Only disable at the moment the reset key is pressed.

The default start and stop conditions can be modified using the installation program. (See paragraph 18.5 Prog 31 “set alarm buzzer”)

The volume of the internal buzzer can be adjusted from 0 up to 4 (factory default: 2). When connecting the external buzzer (optional accessory, supplied by ADESYS), its volume can be adjusted to three levels.

5.2 Flashlight

The Octalarm is equipped with a flashlight output (as option deliverable). As opposed to the alarm buzzer, the flashlight cannot be turned off in the event of an alarm by using the reset key. The flashlight can only be switched off by cancelling the alarm or by switching off the alarm selection key.

The flashlight reminds the user of the fact that the alarm has in fact been reset, but the cause is still not resolved.

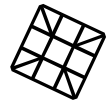

6. OPERATION

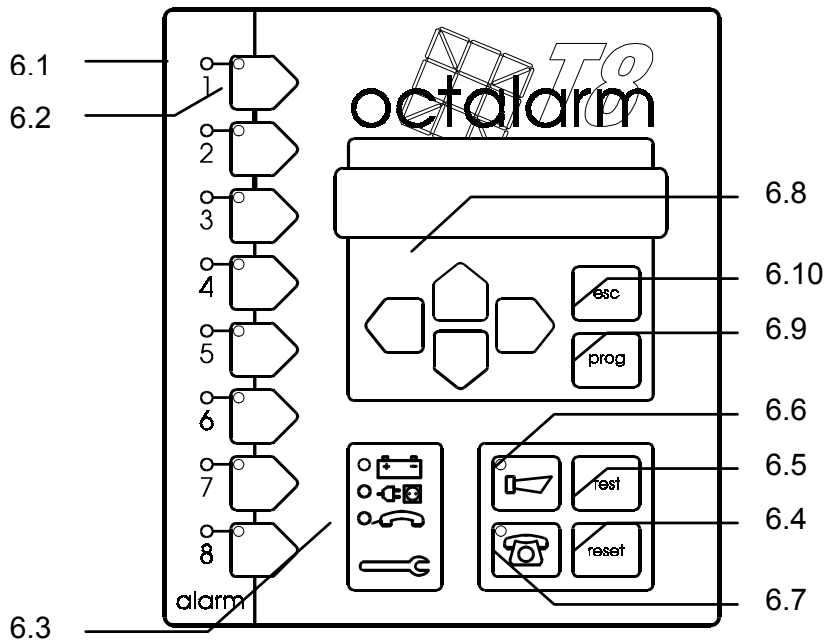

6.1 Alarm indicators

The status of an alarm channel is indicated as follows by the red LED's:

- LED off: no alarm.
- LED on: alarm.
- LED blinks: alarm coming up. The alarm has been detected at the input of the reporter, but is not being relayed since the set alarm delay time for this channel has not yet elapsed. The indicator will switch off when the alarm expires in the course of this period. In case the alarm still exists after the determined time, the indicator will light up continuously and the message will be reported.

6.2 Alarm channel selection keys

Using these keys, the message transmission can be switched off for each alarm channel (at Octalarm-T16: per two alarm channels). The green indicator in the key lights up in case the passing of the report is enabled. To avoid the transmission of the message being interrupted accidentally (e.g. while cleaning), the key has to be kept depressed when turning off.

 When an alarm channel is switched off (green LED off), an incoming alarm on the relevant channel will not be reported.

6.3 Device malfunction indicators

The Octalarm periodically checks the major connections and facilities. A defect will be signalled. The following malfunctions will be reported using individual LED's:

- battery failure
- mains failure
- telephone line interrupted or a failure in the mobile network (model -G).

When the telephone line indicator lights up without reason, this function can be switched off. See

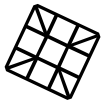

chapter 18.6 Prog 41 "set dialler"

6.4 Reset key

Press this key to disable the buzzer and to interrupt the telephone report.

6.5 Test key

This key allows you to test the main alarm functions in a quick and convenient way. See part 13 "TESTING" for the test options.

6.6 Buzzer key

The key to switch on/off the built-in buzzer and the signallers that may be connected externally. The indicator in the key lights up in case the buzzer is switched on. To avoid the buzzer being disabled accidentally (e.g. while cleaning), the key has to be kept depressed when turning off.

6.7 Telephone dialler key





Key for switching on/off the telephone report. The LED inside the key lights up in case the telephone dialler is switched on. To avoid switching off the telephone report accidentally (e.g. while cleaning), the key has to be kept depressed when turning off.

 In case the telephone dialler is switched off (LED off), an alarm will not be reported by telephone. Calling up the Octalarm in order to receive the alarm status by telephone will, however remain possible.

6.8 Display and cursor keys

The display is used for:

- the menu-driven setting of telephone numbers by the user
- the menu-driven programming of installation data by the installer
- showing the progress status of a telephone report
- showing possible alarms or device malfunctions.

The cursor on the display blinks whenever a value can be entered or an option can be chosen during the set-up. Use the cursor keys  and  to move the cursor around and the keys  and  to modify the value or the option at the cursor's position. Every new setting has to be confirmed using the Prog-key.

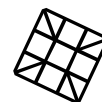

6.9 Prog-key

The key used for configuring the telephone numbers and for programming the installation data by the installer. To set the telephone numbers, the key has to be pressed shortly. This key is also used to confirm and store input. For further information about the set-up, see part 7 "SET".

⚠ By pressing the Prog-key repetitively, the display shows all current settings without altering them. In case a setting has to be modified, all questions asked have to be answered, until the message `SETTINGS STORED` appears. Quitting the set-up program during configuration by using the esc-key, will restore all previous settings!

⚠ In case this key is pressed prolonged (five seconds), the Octalarm will switch over to the installation program. The text `Prog 10 SET DISPLAY CONTRAST` will appear on the display. Press the esc-key to leave this program. The settings in this program require understanding of technical matters and are only intended for the installer. Modifications introduced arbitrary can lead to an alarm being reported wrongly or not at all.

6.10 Esc-key

Press the esc-key in order to quit a configuration or a program on the display and to return to the previous menu without saving a possible modification. Also use this key to end the configuration or the programming and to return to the standard program of the Octalarm.

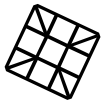





7. SET CALL NUMBERS

Pressing the Prog-key for a short time will start the set up of the call numbers. The general report program will be closed (all LED's switched off) and the Octalarm will guide you by asking some questions.

Up to 10 call numbers can be set. Each call number is assigned to a letter (A through J) and has its own reset procedure. Defining all numbers is not necessary. Numbers which have not been set will be skipped automatically.



A call number can be set as follows:

-  Press the Prog-key for a short time. On the display appears: A:REPORT TO.....
-  If desired, select an alternative call number (A-J) using \triangle or \square .
-  Press the Prog-key for a short time in order to confirm the selected number.
-  Using \triangle or \square , select which telephone connected to the telephone network, will receive the report and confirm this using the Prog-key. You can choose from the following options:
 - report to a telephone. (see paragraph 4.3.1 Report to telephone)
 - report to a pager. (see paragraph 4.3.2 Report to pager)
 - report to a mobile telephone. (see paragraph 4.3.3 Report to mobile telephone)
 - report to a reporting service. (see paragraph 4.3.4 Report to reporting services)A number can be erased completely by selecting (NOT DEFINED)

 Confirm each new or altered setting by pressing the Prog-key repeatedly, until the message SETTINGS STORED appears on the display. Quitting the set-up program during configuration by using the esc-key, will restore all previous settings!





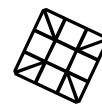

 After erasing the only call number set for a particular alarm, it is no longer possible to report this alarm by telephone. Therefore, first refer to "dialler" on the list of settings made up by the installer (see "**Fout! Verwijzingsbron niet gevonden.**") before erasing any number.

7.1 Report to a telephone

-  The Octalarm asks for the number to be dialled. Use \square or \triangleright to move the cursor to the field for setting or changing a digit. Now you can enter the digit using the \triangle and \square key. The following characters may be used for settings as well:
 - - : setting a delay for a dialling tone (e.g. if the Octalarm is connected to a home exchange, requiring a pause after dialling 0 in order to wait for the dialling tone of the outside line).
 - , : indicates a 2 seconds delay during the dialling and can for example be used if one has to wait for an undefined dialling tone.
 - \blacksquare : used in combination with the \square and \triangleright keys to insert or delete digits at the position of the cursor.
-  Confirm the entered number using the Prog-key.
-  Select the desired reset procedure. See paragraph 7.5 "Set reset procedure".



7.2 Report to a pager

-  Select the pager type. The following options are available:
 - tone-only pager, (see paragraph 7.2.1 “Characteristics of a tone-only pager”)
 - (alpha) numerical pager, (see paragraph 7.2.2 “Characteristics of an (alpha) numerical pager”)The Octalarm has an individual report code or text message for each type of pager and for each alarm channel. For a summary of the default settings, see paragraph 4.3.2 “Report to pager”.
-  Confirm the selection using the Prog-key.
-  In case a numerical or alpha-numerical pager has been selected, the Octalarm asks for the pager type as well.
-  The Octalarm now asks you to enter the call number or the number of the paging service. Use \square or \square to move the cursor to the field for setting or changing a digit. Now you can enter the digit using the \triangle and ∇ key. The following characters may be used for settings as well:
 - - : setting a delay for a dialling tone (e.g. if the Octalarm is connected to a home exchange, requiring a pause after dialling 0 in order to wait for the dialling tone of the outside line).
 - , : indicates a 2 seconds delay during the dialling and can for example be used if one has to wait for an undefined dialling tone.
 - \blacksquare : used in combination with the \square and \square keys to insert or delete digits at the position of the cursor.
-  Confirm the entered number using the Prog-key.
-  Depending on the selected pager type, the Octalarm can ask some additional questions, such as:
 - `pager number` : this question will only appear when using a pager with a general paging service extension number, followed by a unique pager number.
 - `pin code` : this question will appear for pagers using some sub-address. (These pagers do not involve any subscription expenses because many pagers are placed on one single subscription. Separation takes place by the sub-address in the report code.) In case you do not have to use a PIN code for your pager, you can leave this question unanswered.
-  Select the desired reset procedure, see paragraph 7.5 “Set reset procedure”.

7.2.1 Characteristics of a tone-only pager

This pager transmits a tone code and is sometimes equipped with a small numeric display. The pager is supplied with 4 or 8 individual call numbers, with the transmitted tone code being determined by the last digit. Nevertheless, the last digit is not important to the Octalarm.

 When setting the call number, only one of the numbers provided must be entered. The Octalarm itself will alter the last digit in order to transmit the right tone code for the right alarm channel.

7.2.2 Characteristics of an (alpha) numerical pager

This pager disposes of a display on which a user-defined numerical code or an alpha-numerical text can be shown. Before the report can take place, one has to select the call number. Next, the report code (and in some cases an additional pager number or sub-address) must be entered using a telephone or a modem.

 Attention: some numerical pagers are connected to paging services that are not able to send defined acceptance signals on behalf of automatic dialling devices. Reporting to these kind of pagers is therefore not possible!

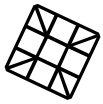

7.3 Report to a mobile telephone

 Select the option with which the report to a mobile telephone has to take place. The following options are available:

- report using SMS.
- report using a tone code or voice report (only for version -S).

The Octalarm disposes of an individual alpha-numerical message for every single reporting channel on behalf of reports using SMS (Short-Message-Service). For a summary of the default settings, see paragraph 4.3.2 "Report to pager".

A tone code or voice reports to a mobile telephone function in the same way as to a regular telephone.

 Confirm the selection using the Prog-key.

 The Octalarm now asks you to enter the call number / extension number or the number of the SMS service. (model -G does not ask this question) Use \square or \triangleright to move the cursor to the field for setting or changing a digit. Now you can enter the digit using the \triangle and \triangleright key. The following characters may be used for settings as well:

- - : setting a delay for a dialling tone (e.g. if the Octalarm is connected to a home exchange, requiring a pause after dialling 0 in order to wait for the dialling tone of the outside line).
- , : indicates a 2 seconds delay during the dialling and can for example be used if one has to wait for an undefined dialling tone.
- \blacksquare : used in combination with the \square and \triangleright keys to insert or delete digits at the position of the cursor.

 Confirm the entered number using the Prog-key.

 In case of an SMS report, the Octalarm will ask for the extension number.

 Select the desired reset procedure, see paragraph 7.5 "Set reset procedure".

7.4 Report to a reporting service

Select the kind of reporting service.

The Octalarm disposes of an individual numerical or alpha-numerical message for each alarm channel. For a summary of the default settings, see "Report to pager".

 Confirm the selection using the Prog-key.

 The Octalarm now asks you to enter the call number. Use \square or \triangleright to move the cursor to the position where a digit has to be entered or modified. Now you can enter the digit using the \triangle and \triangleright key. The following characters may be used for settings as well:

- - : setting a delay for a dialling tone (e.g. if the Octalarm is connected to a home exchange, requiring a pause after dialling 0 in order to wait for the dialling tone of the outside line).
- , : indicates a 2 seconds delay during the dialling and can for example be used if one has to wait for an undefined dialling tone.
- \blacksquare : used in combination with the \square and \triangleright keys to insert or delete digits at the position of the cursor.

 Confirm the entered number using the Prog-key.

 Select the desired reset procedure, see paragraph 7.5 "Set reset procedure".

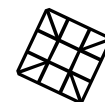

7.5 Set reset procedure

It is possible to choose from the following reset procedures:





- Reset during call (for reports to a telephone)
- Reset by the service (for reports to a pager, a reporting service or an SMS-message in case of a mobile telephone)
- Reset by calling back.



7.5.1 Reset during call

-  Select this option and confirm using the Prog-key
-  Enter the (compulsory) 4-digit reset code and confirm using the Prog-key.
-  Enter the delay time to be taken into account between a failed report attempt and a new dialling attempt and confirm using the Prog-key. The following text will appear on the display: `SETTINGS STORED`.

7.5.2 Reset by the service

-  Select this option and confirm using the Prog-key.
-  Enter the delay time to be taken into account between a failed report attempt and a new dialling attempt and confirm using the Prog-key. The following text will appear on the display: `SETTINGS STORED`

7.5.3 Reset by calling back

-  Select this option and confirm using the Prog-key.
-  Enter the time in which the Octalarm has to be called back and confirm using the Prog-key.
-  If necessary, enter the reset code to be applied and confirm using the Prog-key. The following text will appear on the display: `SETTINGS STORED`.

 Not entering a reset code might lead to an accidental reset of the Octalarm, in case someone happens to call the Octalarm within the set delay time! Therefore, the use of a reset code is strongly recommended.

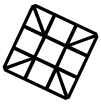

 A reset code can only be entered using a tone dialling telephone.

 Do not set the wait time if failed or the call back time too short in order to avoid the reporting attempts being carried out too soon after one another. The reporting stops after 15 unsuccessful attempts.



8. CALL BACK TO RESET AN ALARM

Depending on the reset procedure programmed with the call number, you have to call back the Octalarm in order to acknowledge the alarm report and to reset the transmission.

-  Dial the number of the Octalarm.
-  Provided the telephone line is not engaged, the Octalarm will answer the call after 2 rings and transmit the alarm twice using a recognizable tone code or a recorded voice message (version -S). See paragraph 4.3.1 "Report to telephone" for the characteristics of the tone codes.

8.1 Reset without using a reset code

In case the call number is not provided with a reset code, the alarm report is followed by an extended beep (5 seconds) indicating the Octalarm is being reset.

-  In case no reset code is set, it may be possible that, if someone happens to call the Octalarm within the set delay time, the Octalarm is reset accidentally! Therefore, the use of a reset code is strongly recommended.

8.2 Reset using a reset code

In case the call number is provided with a reset code, after the alarm report, the Octalarm will send short waiting beeps with extended pauses in between, indicating the reset code to be entered now. Enter the reset code using the telephone. If the code is right, an extended beep (5 seconds) is heard and the alarm is reset. In case of an incorrect reset code, you hear some short error beeps shortly after each other and the Octalarm waits for the correct reset code. The connection will be interrupted after 2 minutes.

After the reset code has been accepted, the Octalarm will send waiting beeps again to give the caller the opportunity to send commands for switching or remote programming. See paragraph 10 "SWITCHING THE RELAY OUTPUT BY TELEPHONE" respectively paragraph 17.1.3 "Programming using a telephone line".

-  A reset code can only be entered using a tone dialling telephone.

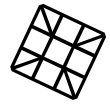

9. RETRIEVE ALARM STATUS BY TELEPHONE

This option enables you to retrieve the alarm status of the guarded object using a telephone. In case the telephone dialler key is switched off, the status report can be retrieved anyhow.

Dial the number of the Octalarm. Provided the telephone line is not engaged, the Octalarm will answer the call and put through all present alarms twice, using a recorded voice message (for version -S) or a recognizable tone code. See paragraph 4.3.1 "Report to telephone" for the characteristics of the tone codes.

In case no alarm is present, the Octalarm sends an extended beep of 5 seconds.

 In case the Octalarm is connected to a analogue telephone line together with communication equipment provided with answering facilities (modem, fax and such) the usage of this option could cause problems. If necessary, alter the number of signals after which the Octalarm has to answer the call or completely switch off this function using the installation program.

10. SWITCHING THE RELAY OUTPUT BY TELEPHONE

The Octalarm is equipped with a relay control output. A connected relay can be controlled at a distance using a telephone, for example to:

- reset an alarm device
- temporarily release an entrance door
- switch on or off the ventilation, the lighting or the burglar alarm.

The control can take place as follows:

 Dial the number of the Octalarm, listen to the possible alarms and wait for the short waiting beeps.

 Enter one of the following switch commands:

- # 1 # , to switch on,
- # 0 # , to switch off,
- # 2 # , for a switch pulse of 10 seconds.

 In case an access code is set, the switch command has to be given as follows: # *switch command* # *access code* #. The access code is entered in the installation program.

 Wait until the acceptance tone is sent back, the command will then be executed. A short continuous error beep sounds in case of an incorrect code.

 Remote switching is only possible using a tone dialling telephone.

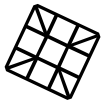

11. NIGHT TIME MODE

The Octalarm -T4, -T8 and -T16 are equipped with a night time mode. When the Octalarm operates in night time mode, this is indicated on the display.

The night time mode influences the following functions:

- Start conditions (delay times included) of the telephone report.
- Start and stop conditions (delay times included) of the built-in buzzer and the external signal devices.
- The volume of the built-in buzzer.
- Locking the keyboard.

The night time mode is set using the installation program.

The night time mode cannot be activated on the Octalarm itself. For activating, it disposes of an individual input that is to be connected to external devices such as a burglar alarm, a key switch, a time switch, an access control system, etc.

Example of a configuration

If the night time mode input is connected to a burglar alarm, the night time mode is activated automatically the moment the burglar alarm is switched on, for instance when leaving the location.

The reports can be carried out as follows:

Reports during daytime

- The acoustic alarm sounds instantly after detecting an alarm.
- The telephone report only starts after 5 minutes, allowing a prior reset of the Octalarm.
- The acoustic alarm does not stop until the device has been reset or if a possible telephone report has succeeded.
- The operation of the Octalarm will not be locked.

Reports during night time

- The telephone report starts immediately after receiving an alarm, without any delay.
- The acoustic alarm only sounds after the telephone report fails. Possible neighbours can be alerted through these signals.
- The operation of the Octalarm will be locked.

 Using daytime as well as night time mode, the telephone key and the buzzer key are to be operated as usual (providing the operation not being intentionally locked). However, while switching from daytime mode to night time mode or the other way round, the night time mode settings, as selected in the installation program, are re-applied.

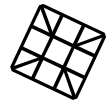

12. MAINS FAILURE

The Octalarm is equipped with a built-in, maintenance free standby battery. This keeps the Octalarm functioning in case of a mains failure.

12.1 Mains failure report

The Octalarm will report a mains failure through an acoustic signal and/or by telephone using an especially reserved internal reporting channel. For the report codes being used, see paragraph 4.3 "Alarm channels and report codes".

12.2 Battery empty report

In case the battery is almost run down during a mains failure, this will be reported through an acoustic signal and/or by telephone using the "battery empty" channel. For the report codes being used, see paragraph 4.3 "Alarm channels and report codes".

12.3 Back up supply

During a mains failure, the period that can be backed up with the built-in battery strongly depends on the operation mode and the external signal devices. In general, a new battery obtains a back up supply of:

- approximately 15 hours in standby mode
- approximately 10 hours in case of a continuous acoustic alarm through the built-in buzzer.
- approximately 3,5 hours in case of a continuous acoustic alarm through the built-in buzzer and the external connected signal devices.

12.4 Automatic battery test

During normal use, the battery will be recharged continuously to its maximum level.

The battery performance is tested automatically every month. In case the battery does not dispose of sufficient capacity during the test (less than 30% of the original capacity), the red indicator "battery empty" will light up and the message "battery failure" appears on the display. The internal buzzer will be activated and a telephone report using the "battery empty" channel will be issued as well.

The Octalarm will continue to function during the battery test.

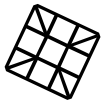

13. TESTING

The test key enables you to test most options of the Octalarm in a quick and convenient way. It also enables you to find possible set-up errors.

13.1 Optic and acoustic alarms test

Press the test key. All indicators will illuminate and the built-in buzzer and the external signal devices will be activated. On the display appears: -OCTALARM-TEST- , followed by the type number OT2, OT4, OT8 or OT16, possible followed by:

- -S: model with voice messages instead of tone code messages,
- -I : model adjusted for the ISDN network,
- -G: model for the mobile GSM network,
- or a combination of the above.



The test can be interrupted using the reset key. After 5 seconds, the test will be interrupted automatically.

13.2 Telephone report test

Press the test key followed, within 5 seconds, by the selection key of the alarm channel to be tested. The set report procedure for the relevant channel will be passed through completely. With the model for analogue or ISDN connections, the built-in speaker produces all signals on the telephone line, making it possible to trace possible set-up errors of telephone numbers, reporting procedures and such. It is not possible to listen in on conversations with the GSM model.

14. SWITCH OFF COMPLETELY

The Octalarm does not dispose of an on/off switch on the operating panel. The following has to be done to completely turn off the device:

-  Disconnect the plug from the power socket,
-  Keep the reset key on the operation panel or the reset key underneath the connection cover depressed until the display and all the indicators have been turned off.

Connecting the plug to the power socket will automatically turn on the Octalarm.

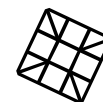

15. ERROR MESSAGES

Installation or set-up errors may give the following error messages:

Display messages	Cause	Solution
BATTERY FAULT, REPLACE BATTERY	The Octalarm has detected that the emergency battery capacity has dropped below 30% of the original value. There is a possibility that a telephone warning of a network error cannot be passed on.	Have the battery replaced by professionals.
SHORTCIRCUIT IN THE SENSOR NETWORK	A short-circuit has been detected in the Sensor network cable.	Check the cable circuits.
TELEPHONE CONNECTION DEFECTIVE	There is no power on the telephone line, owing to a failure, or is dropping to an extremely low value during the use of another machine or peripheral connected to the same line.	Check the telephone line. The telephone line monitoring can be switched off, see also prog. 41 "adjusting the dialler".
SETUP ERROR ISDN CALL NUMBER XX	A message has been sent to a non-existent ISDN call number.	Check the call number installed.
ISDN S-BUS DEFECTIVE	The Octalarm has detected that there is no power on the ISDN line (i.e. the S box).	Check the ISDN line and the ISDN connection cables.
ISDN NETWORK ERROR XX	There is a failure in the service provider's ISDN network.	Wait for a while to see whether the failure continues. If it does, contact your service provider.
ISDN MODULE DEFECTIVE	The inbuilt ISDN module is defective.	Send the Octalarm to be repaired.
GSM NETWORK: NO INCOMING SIGNAL	There is no connection with the mobile network, possibly because of a fault in the network or because the antenna is defective or not properly placed.	Check whether the mobile network is present. If it is, check and/or move the antenna.
GSM: NO SIM CARD	No SIM card has been inserted, or the inserted card is not recognized.	Check the SIM card under the protective cover.
GSM BLOCKED! PIN CODE INCORRECT!	An incorrect PIN code has been entered, blocking the SIM card.	Unblock the SIM card, see prog. 41, "adjusting the dialler".
GSM MODULE DEFECTIVE	The inbuilt GSM module is defective.	Send the Octalarm to be repaired.

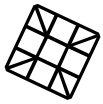



16. INSTALLATION

16.1 Placement

Install the Octalarm at a location not exposed to direct sunlight or other heat sources. Choose a mounting location, shielded against penetration of moisture into the device.

The Octalarm can be placed on a table or it can be mounted onto a wall.

All connections are situated in the connecting area underneath the ribbed protective cover. Remove the cover by pulling it up or aside on its corners.





-  Connect the Octalarm to a power socket with an earth connection. A proper grounding offers maximum overvoltage protection on the telephone network and on the in- and outputs.
-  The GSM model Octalarm has a higher transmission frequency than standard mobile telephones. In certain conditions, this may affect the functioning of nearby electronic equipment. If an external antenna is used, the effects depend on the distance from the antenna to the nearby equipment.

Desk top installation

Detach the hindmost breakaway partition for leading the connection cables into the back. After connection, fix the connection cables to the little bridges on the backplane, avoiding tensile strain.

Mounting onto a wall

The backplane of the Octalarm has two notches for mounting it onto a wall. Install the Octalarm as follows:

-  Screw the Octalarm against the wall using the middle hole (only visible from the back), level the device and fix it with a screw through the slit in the connection compartment.
 -  Remove the lower breakaway partition of the connecting compartment in order to lead the connection cables through. Preferably, keep the hindmost partition intact to minimize the penetration of moisture and dust.
 -  After connection, fix the connection cables to the little bridges on the backplane, avoiding tensile strain.
-  In case the Octalarm is placed next to other equipment, reckon with sufficient space necessary for removing the protective cover and for the connectors to be in easy reach.
 -  Take care to attach the telephone cable or antenna cable (with the model -G) to the underlying tensile relief bridge in order to prevent damage caused by pulling the cable loose sideward.

16.2 Connection diagram

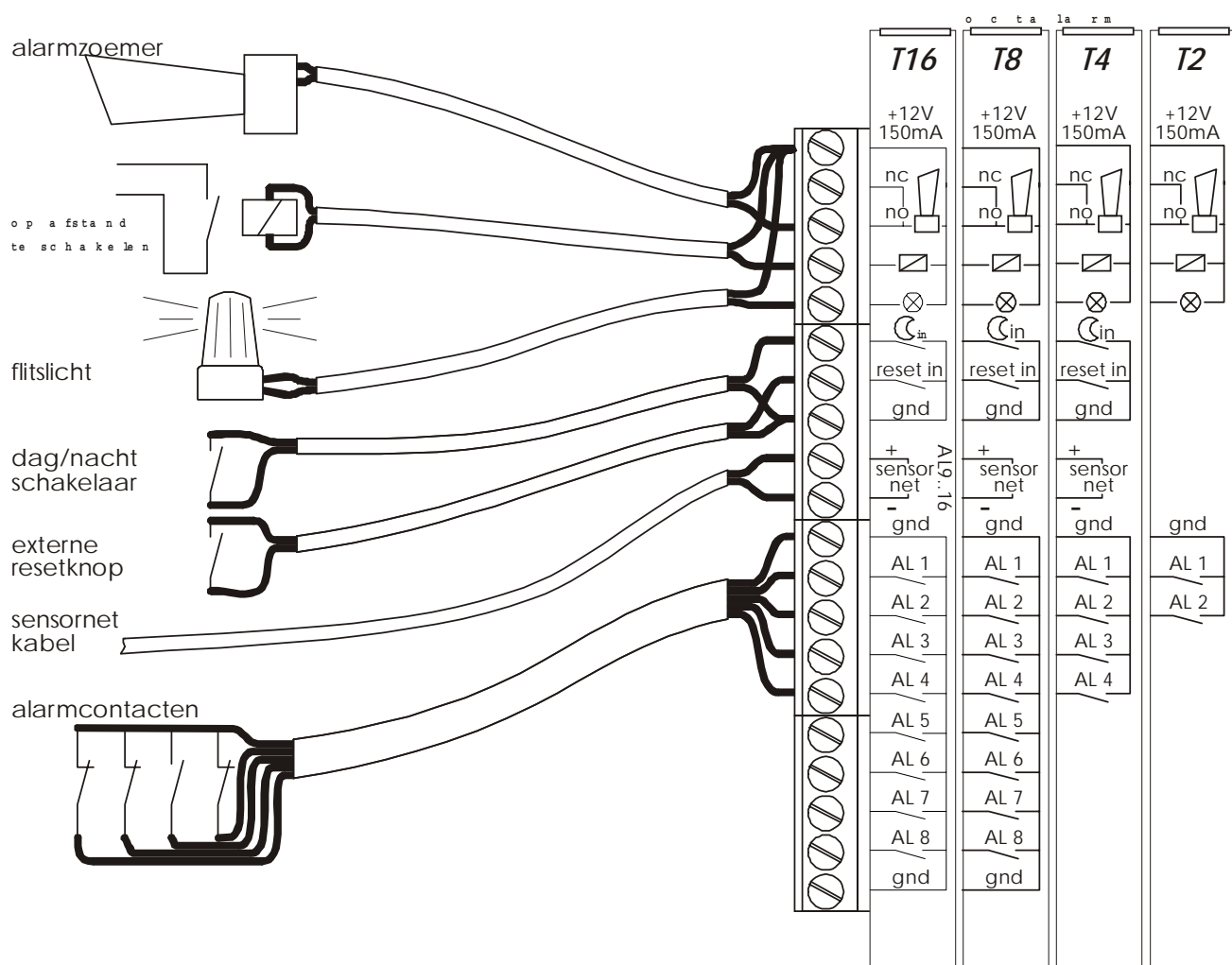
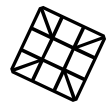

16.3 Connection of inputs

⚠ All inputs have to be activated by potential-free contacts.

16.3.1 Alarm inputs

Both normally open and normally closed contacts can be applied.

For the connection, it is possible to choose between:

- a direct connection to the Octalarm, or
- a connection through Sensornet (only possible for Octalarm -T4 and -T8). Using a Sensornet connection can save on wiring, because all inputs are connected using one single two-core cable.

The Octalarm-T16 works with either type of connection: the alarm contacts for points 1-8 should be connected directly, points 9-16 should be connected via the Sensor network.

16.3.1.1 Direct connection

Connect the potential-free alarm contact to the alarm input AL .. and to the GND terminal.

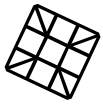

16.3.1.2 Connection through Sensornet

The Sensornet connection allows you to connect more than one alarm input using one single 2-core cable (2 x 0.75mm at minimum, 1.000m at maximum). For this, coded terminal blocks are needed, which are available in a set of 4 pieces, to be supplied as an optional accessory with the Octalarm -T4 or T8.

Connect the alarm contacts as follows:

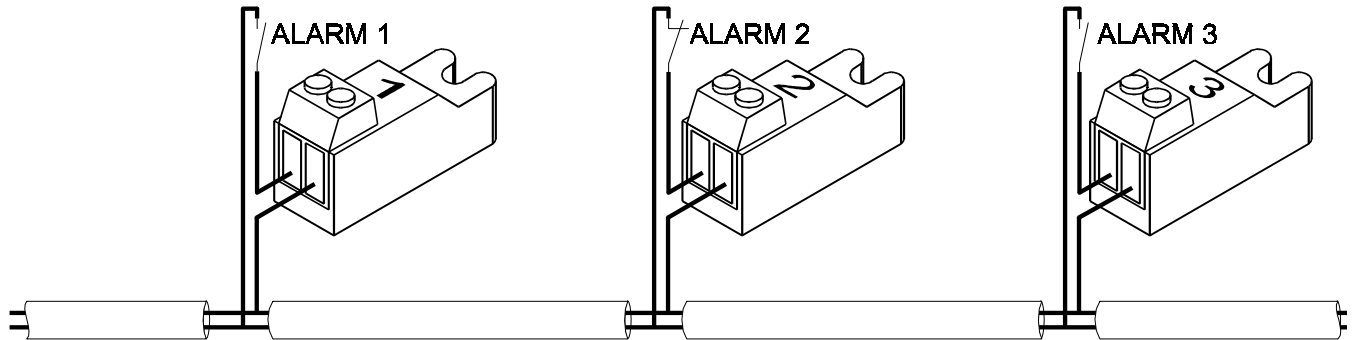

Every connection block is coded. The code and the connection polarity, together with the Octalarm model used, determine which alarm entry point is activated, according to the following table:

Connection block number:	With polarity:	With Octalarm-T4 activates:	With Octalarm-T8 activates:	With Octalarm-T16 activates:
1	+ / -	alarm 1	alarm 1	alarm 9
2	+ / -	alarm 2	alarm 2	alarm 10
3	+ / -	alarm 3	alarm 3	alarm 11
4	+ / -	alarm 4	alarm 4	alarm 12
1	- / +	alarm 1	alarm 5	alarm 13
2	- / +	alarm 2	alarm 6	alarm 14
3	- / +	alarm 3	alarm 7	alarm 15
4	- / +	alarm 4	alarm 8	alarm 16

⚠ The Octalarm-T4 and -T8 are allowed to "see" each terminal block only once! Therefore, never connect two identical blocks (e.g. in order to let both of them activate the same alarm input), because this will cause malfunctions or the wrong input being activated!

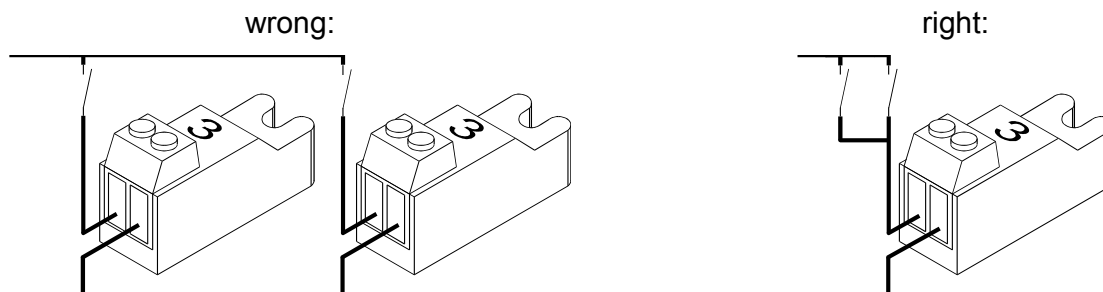

16.3.2 Input night time mode

Input to be able to activate the night time mode. Closing this contact will make the acoustic alarm and the telephone report function according to the night time mode settings, see paragraph 18.11.

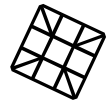

16.3.3 Input external reset contact

Input in order to reset the Octalarm by remote control. Just like when pressing the reset key on the operation panel, the report will be interrupted as soon as the contact is made. The input only reacts to the closing of the contact. A subsequent report will thus not be blocked in case the contact remains closed.

16.4 Connection of outputs

 All the following outputs are connected through one connection cable to the 12V terminal on top of the terminal block and another cable to the relevant output terminal. The maximum current available for all the externally connected devices is 150 mA.

16.4.1 Output external signal light

This output is activated as long as one of the inputs is in a state of alarm and the relevant selection key is switched on. This output remains active even after the acoustic alarm or the telephone report is reset. The output can be used for the direct control of a 12 V flashlight or (through a 12 V relay) a large 230 V light on a manifest place indicating the alarm still applies. Switching off only takes place when the alarm expires or when the selection key concerned is switched off.

16.4.2 External buzzer outputs

Outputs for connecting additional acoustic signal devices or for controlling existing alarm systems. There are two connection options:

- Output “NO” (Normally Open) will be active in case of an alarm. It can be used for the direct control of 12 V buzzers. Fitting in a 12 V relay allows you to switch heavier equipment.
- Output “NC” (Normally Closed). It is active in rest on the contrary, and drops out in case an alarm occurs. The Octalarm can be connected to another (existing) alarm circuit using a 12 V relay on this output, functioning through break contacts.

Both outputs are connected simultaneously with the internal buzzer.

16.4.3 External relay output

An external 12 V relay can be connected to this output. This relay can be switched on and off from a distance by telephone.

16.5 Connection of the telephone line

Connect the Octalarm to the telephone network using the supplied telephone joint plug. Preferably, reconnect all the remaining telephone equipment to this connector. In case of an alarm, the Octalarm will interrupt all the connected equipment, so that the alarm is always given priority.

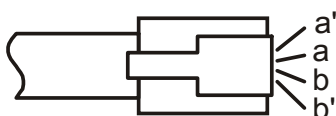

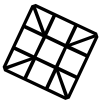

The Octalarm only needs the A and B connections to the telephone network to function properly. When not active, A and B are put through to A' and B', respectively. The most common type of connection is:

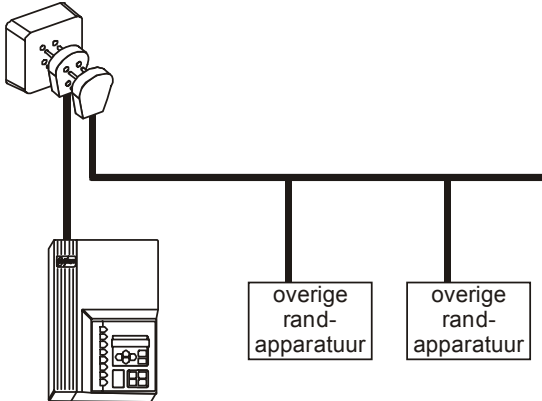

⚠ If the Octalarm is connected to a fully wired RJ-11 main connection by the telephone company, without a connecting plug, it may cause a short-circuit in the telephone network, owing to the A-A' and B-B' reconnection when not active. If so, set up an additional RJ-11 connection box with only the two centre pins connected, or else use a 2-core connection cable rather than the standard 4-core model supplied.

⚠ Avoid connecting the Octalarm behind a telephone switchboard. In the case of a network failure, the connections of telephone switchboards often stop working. This will prevent the Octalarm from sending a telephone alarm!

If the Octalarm has to be connected together with a telephone switchboard, do so according to the following diagram:

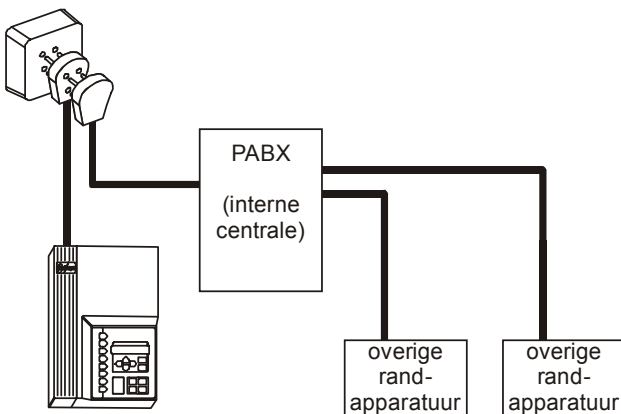

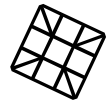

16.5.1 ISDN telephone connection

(only for Octalarm ISDN models)

Connect the Octalarm's NT1 connection to the telephone company's NT1, using the cable provided.

In the case of an alarm, the Octalarm will first check whether a line is free. If so, the alarm is started. If not, the Octalarm will terminate the current connections by giving a termination command. Both the telephone company and the peripheral equipment will then free the lines. In order to ensure that none of the peripherals fail to terminate the connection (because of behaviour that is not entirely according to the telecommunication guidelines), the Octalarm also has a disconnection relay, with which the peripherals can be fully disconnected, if necessary. **It is therefore advisable to reconnect all other ISDN equipment to the Octalarm's TEL connection.**

The recommended connection scheme is as follows:

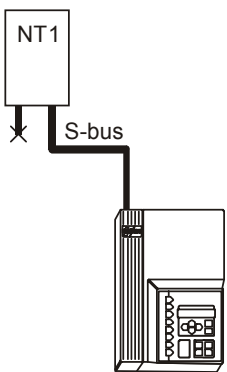

Cable disconnection

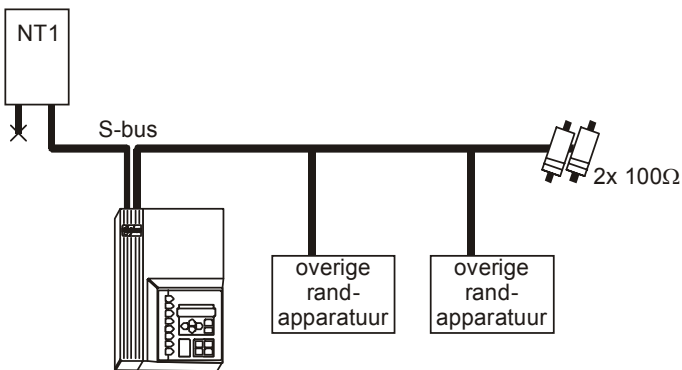
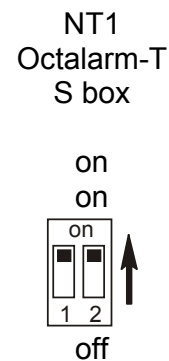

Cable disconnection

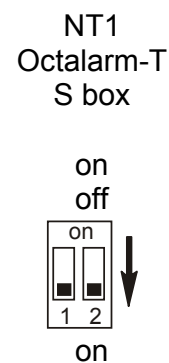

If the S box cabling does not allow any of the connection schemes shown above, one of the following schemes may be usable. However, full disconnection cannot always be guaranteed in these schemes. If this is important for the purpose of the equipment, the disconnection will have to be tested for each peripheral item connected directly to the NT1.

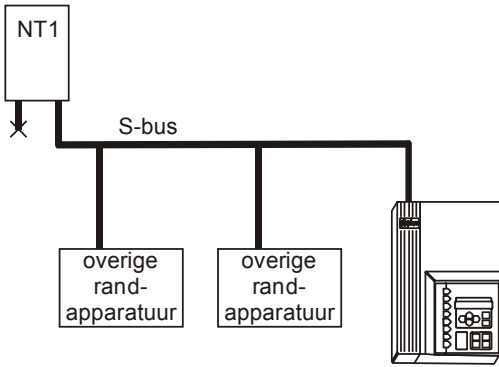
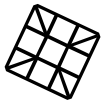

Cable disconnection

NT1
Octalarm-T
S box

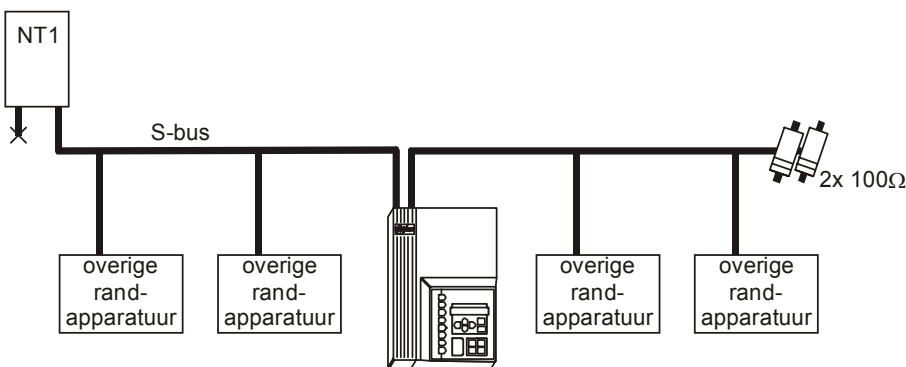
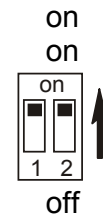

Cable disconnection

NT1
Octalarm-T
S box

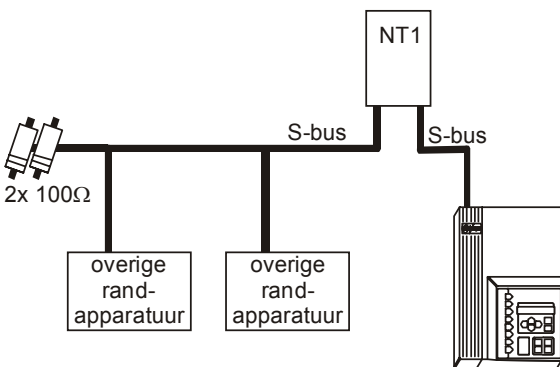
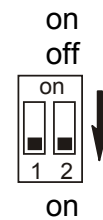

Cable disconnection

NT1
Octalarm-T
S box

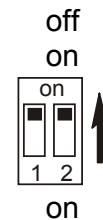

⚠ Always connect the Octalarm to the NT1's S box, avoid connecting it to an S box behind a switchboard, because:

- The internal S box of the switchboard will often stop working in the case of a network failure, preventing the Octalarm from sending a telephonic warning,
- The internal S box of a switchboard may work according to different standards than the S box of the telephone company's NT1, so that faultless operation cannot be guaranteed.

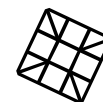

16.5.1.1 General guidelines for ISDN

The following guidelines should be taken into account for a reliable ISDN wiring:

- No more than 2 cables may lead from an NT1 connection to peripheral equipment. No star connections may be used to connect more peripherals.
- The S box cable may not be longer than 150m.
- For cables up to 10m in length, standard round 4- or 8-core telephone wires are sufficient, also called norm88 cables. For longer cables, use UTP (Unshielded Twisted Pair) of CAT-3 category or better.
- The cable should be closed at both ends with 100Ω between the two cores or each pair of cores. For most ISDN peripherals:
 - NT1: resistors can be adjusted,
 - Telephones, faxes, modems etc.: some can be adjusted, but most do not have resistors,
 - Telephone switchboards: some can be adjusted, but most have standard resistors installed.
 - Octalarm-T: resistors can be adjusted.
- If necessary, additional disconnection resistors, in the form of connecting plugs, splitters, or integrated in connection boxes, are available at any telecommunications store.
- Changing cores or pairs of cores will cause improper functioning (unlike with analogue lines).

16.6 Placing and connecting the GSM antenna

(only for Octalarm GSM model)

16.6.1 Internal antenna

Connect the two antenna plugs in the connection compartment to one another. Connect the antenna provided to the connector on the outside of the cover. Always place the antenna upright for maximum signal strength.

16.6.2 External antenna

Place the external GSM antenna using the instructions in the set-up manual provided. In areas with reduced reception, place the antenna as high as possible, and always upright. Connect the cable provided to the connector in the connection compartment.

 After placing the antenna, always check the field strength of the signal. Press one of the arrow buttons to call it up on the display. Changes in the signal strength are always announced very slowly, please take this into account when moving the antenna, for example.

16.7 Placing the SIM card

(only for Octalarm GSM model)

The SIM card needed for the mobile network is placed as follows:

- Switch off the Octalarm completely,
- Use a sharp object to press the yellow button next to the screw connectors. This will release the SIM card,
- Place the SIM card in the holder and slide it into the alarm,
- Switch the Octalarm on,
- Enter the PIN code of the SIM card using prog. 41, "adjusting dialler" (factory setting: 0000).

 Using a so-called Prepay SIM card is highly inadvisable for alarm purposes. The mobile network

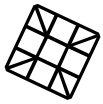

does not allow for alarm diallers to automatically check the calling credit status. Running out of credit will result in the alarm system being blocked!

⚠ The Octalarm has numerous different alarm protocols, some of which are not yet supported by all network providers. See the *GSM enclosure* provided for an up-to-date list.

16.8 Connecting the COM port

The COM port is designed in accordance with the V.24 / RS-232 standard, and provides the following signals:

PIN nr	Name	In / Out	Description
2	TXD	in	Transmit Data
3	RXD	out	Receive Data
4	RTS	in	Request To Send
5	CTS	out	Clear To Send
6	DSR	out	Data Set Ready
7	GND	-	Ground
8	CD	out	Carrier Detect
20	DTR	in	Data Terminal Ready

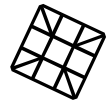

17. PROGRAMMING OF INSTALLATION DATA

After the Octalarm has been placed, the installation dependent parameters such as normally open / normally closed contacts for the alarm inputs, possible delay times and such, have to be set. These settings take place in the so-called installation program. See part 18 "INSTALLATION PROGRAMS".

Each Octalarm is supplied with factory defaults, as generally used in practice.

 Make a note of every modified setting at the back of this manual in order not to lose the overview and to avoid future operation errors. For resetting the default settings, see chapter 18.15.Prog 99 "clear all settings"

17.1 Programming options

The Octalarm can be programmed in the following ways:

- using the operation panel,
- using a PC at the serial interface (RS-232 connection),
- through the telephone line using the built-in modem.
- over the mobile network, using the inbuilt modem (only model -G).

17.1.1 Programming using the operation panel

 Press the Prog-key continuously until after approximately 5 seconds PROG 10: set display contrast display appears on the display. You are now in the installation program.

 Select the number of the program that you want to modify or check the settings by using the \uparrow and \downarrow keys. Press the Prog-key again in order to start the program. In case a blinking setting or cursor appears, a selection can be made using the \uparrow and \downarrow keys. Use the cursor keys \leftarrow and \rightarrow to move the cursor around. Confirm each new setting by pressing the Prog-key.

 Following each modified setting, you must answer all additional questions until the message SETTINGS STORED appears. When the installation program is closed prematurely by using the esc-key, all former settings will be replaced!

 Pressing the Prog-key repeatedly enables you to check the current settings.

 During set-up subsequent menus are partly dependent on data entered earlier. Therefore, it is possible that not all menus described appear on the display during set-up.

17.1.2 Programming using the PC

 Connect the RS-232 connection of the Octalarm to the serial port (COM port) of the PC using a serial cable.

 Launch a terminal emulation program. Examples of such programs are "Procomm", "PC+", "Norton Commander", "Telix" etc. Set the following options for the COM port used: 19.200 baud, no parity, 8 bit data, 1 stop bit.

 Start communication by entering "OT" on the keyboard of the PC. The menu for the Octalarm -T appears.

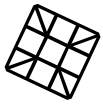

 Scroll through the various menu options using the arrow keys and confirm each choice with the enter-key.

17.1.3 Programming using a telephone line

17.1.3.1 Analogue or ISDN model

Remote programming is possible using the built-in modem of the Octalarm on 2.400 baud (V.22bis).

After establishing the connection, the programming menu of the Octalarm appears. Scroll through the various menu options using the arrow keys and confirm each choice with the enter-key.

The Octalarm disposes of two ways to establish a modem connection:

- Call the Octalarm using a telephone and enter the following code (during the short beeps): "*# 9 # requisite access code ##*". Put the telephone down. Call the Octalarm from a PC with a modem within one minute.
- Call the Octalarm using a telephone and enter the following code (during the short beeps): "*# 9 # requisite access code # telephone number to call back #*". Put the receiver down. The Octalarm will call the number entered immediately and will expect a modem to be available.



Programming by telephone is only possible if the function has been made available beforehand in prog. 61, "setting access code". Remote programming is not possible without an access code.



If the Octalarm has been set so that the alarm status is first transmitted by telephone, it will take longer before the modem connects. Take this into account when setting up the transmitting modem. It may be necessary to increase the waiting time for the carrier. Most modems use the command `ATS7= ...` for this.

17.1.3.2 GSM model

The inbuilt GSM modem allows communication with modems on the analogue network, for remote programming. Set the analogue modem in the PC to 9.600bd. Other speeds may be possible, depending on the network operator. A data supplement to the GSM subscription should not be necessary.

Call the Octalarm using a telephone and enter the following code (during the short beeps): "*# 9 # requisite access code # telephone number to call back #*". Put the receiver down. The Octalarm will call the number entered immediately and will expect a modem to be available.

Once the connection has been made, the Octalarm's programming menu will appear. Use the arrow keys to go through the various options, and confirm each choice with the Enter key.



Programming by telephone is only possible if the function has been made available beforehand in prog. 61, "setting access code". Remote programming is not possible without an access code.

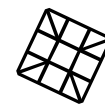

18. INSTALLATION PROGRAMS

18.1 Prog 10 “set display contrast”

The contrast of the display can be adjusted using the \triangle and \square keys.

18.2 Prog 11 “ show version number”

After the Prog-key is pressed, the software version is shown on the display.

18.3 Prog 21 “set alarm inputs”

Select the output of which you want to modify or check the settings of. After confirming the selection using the Prog-key, the following settings are available:

CONTACT INPUT 1: NORMALLY OPEN / NORMALLY CLOSED

Select whether the alarm has to be activated through a normally open contact or a normally closed contact on the alarm input.

CONTACT INPUT 1: DIRECT / VIA SENSORNET

Select whether the alarm contact is directly connected to the Octalarm or whether it is connected by means of a Sensornet terminal block (only for Octalarm -T4 and T8). See paragraph 16.3.1.2 “Connection through Sensornet”.

ALARM DELAY: 00:00 (MIN:SEC)

Set the desired alarm delay time. The alarm will only be issued after the activation of the alarm exceeds this delay time.

MEMORY FUNCTION ON ALARM: OFF / ON

Define whether the report has to stop or whether it must be finished in case the alarm expires.

- OFF : both the local and telephone report are interrupted immediately in case the alarm expires.
- ON : the report will be completely finished in case the alarm expires. With this option, the following additional question regarding the alarm indicator appears:

Reset memory: after tel eph. Reset / by reset key

Define whether the alarm indicator has to extinguish by telephonic reset or whether it only can be extinguished by pressing the reset key.

 In case an alarm expires and re-occurs after having been reported, while the setting on is activated, the report will start again, even if the alarm indicator on the Octalarm is still on. Also, the use of this option will not result in reporting a recurring alarm only once.

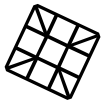

18.4 Prog 23 “set alarm on display”

During an alarm, the Octalarm shows the number of the alarm channel and a user-definable message on the display. The alarm cause can be reproduced in this way (for example "computer failure").

First select the input of which you want to modify or check the settings. After confirming the selection using the Prog-key, the cursor appears on the lower line. Enter the alarm cause here. The maximum text length is limited to 16 characters.

18.5 Prog 31 “set alarm buzzer”

This program allows you to set the start and stop conditions of the internal and external buzzer. The following options are available:

ALARM BUZZER ON: DIRECT AT ALARM / DIALLING FAILURE / AFTER DELAY

Set the start condition for the alarm buzzer:

- DIRECT AT ALARM the alarm buzzer sounds immediately after the detection of the alarm.
- DIALLING FAILURE the alarm buzzer will only sound after the complete failure of a telephone report, also following 15 failing dialling attempts. The alarm buzzer will however sound immediately in case the telephone dialler key is switched off.
- AFTER DELAY the alarm buzzer only sounds after the set delay time has elapsed. With this option, the following additional question appears:

DELAY TIME 01 MIN.

Set the desired delay time here (from 1 to 99 min).

ALARM BUZZER OFF: AFTER TEL RESET / BY RESET KEY / AFTER DELAY

Set the stop condition for the alarm buzzer:

- AFTER TEL RESET the alarm buzzer is switched off after a successful telephone report. The buzzer keeps sounding after 15 failed report attempts. If the telephone dialler key is switched off, the alarm buzzer will sound until the reset key is pressed.
- BY RESET KEY the alarm buzzer only stops after pressing the reset key.
- AFTER DELAY the alarm buzzer stops automatically after the set delay time has elapsed. With this option, the following additional question appears:

DELAY TIME: 01 MIN.

Set the desired delay time here (from 1 to 99 min).

VOLUME INTERNAL BUZZER: 1/2/3

Select the desired volume for the built-in buzzer. The Octalarm enables you to hear the chosen volume during adjustment. (The volume of the external buzzer can be adjusted to three levels using the supplied reducer).

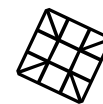

18.6 Prog 41 “set dialler”

18.6.1 Octalarm for PSTN (analogue network)

The following options are available:

DIALLER DELAY: 00MIN

Set the desired delay time here (from 1 to 99 min). The report is only started after the set delay time has elapsed.

AUTO ANSWER: OFF / ON

Here you can define whether you want to retrieve the alarm by telephone:

- OFF the Octalarm does not answer an incoming call,
- ON the Octalarm answers after an adjustable number of rings (see below) and passes on the status of the alarm channels by means of a tone code or a voice message (version -S).

⚠ In case the selected option is `off` and a telephone report is being acknowledged by a call back (only if this is set with the relevant telephone number), the Octalarm answers after 2 rings.

⚠ In case the selected option is `on`, retrieving the alarm status is always possible, even when the telephone dialler key is switched off.

AUTOANSWER AFTER: 05 RINGS

Here you can enter the number of rings (1 through 19) the Octalarm has to wait for before answering an incoming call in order to pass on the alarm status.

DIAL MODE: PULSE / TONE (DTMF)

Here you can define whether the dialling of call numbers has to be done using pulse or tone dialling.

WAIT FIRST DIALLING TONE: YES / NO

Set this option to "no" only if it turns out that the Octalarm does not recognize the first dialling tone (the tone you hear immediately after you lift the receiver). This can be the case if the Octalarm is connected to a (home) telephone exchange, not giving a correct dialling tone.

Telephone line test: on / off

The default setting for telephone line testing is on. If the telephone connection is lost, the warning light and the buzzer will come on. You can turn this setting off if the telephone line test alarm regularly comes on if another telephone connected to the same line is used. (Combinations of the Octalarm with some home or professional switchboards and some telephones may cause problems.)

18.6.2 Octalarm for ISDN (digital network)

The following options are available:

Report delay: 00MIN

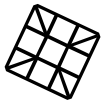

Use this option to set the delay in minutes (from 0 to 99 min). The alarm will not be sent until the set time has passed.

MSN number:

Use this option to set the MSN number (Multiple Subscriber Number) at which the Octalarm has to be available on the S box (without prefix). If no number is entered, the Octalarm will respond to every incoming call. The following question shows next:

CLIP number:

Use this option to set the number (without prefix) with which the Octalarm should identify itself to the call receiver (CLIP, or Caller Line Identification Presentation function). In most cases, this can be the MSN number. If no number is entered, the Octalarm will identify itself with the main ISDN number.

Auto answer: on / off

Use this option to allow remote access to the alarm status:

- OFF the Octalarm will not answer calls to the machine,
- ON the Octalarm will answer after a set number of call signals (see below) and will pass on the status of the alarm channels, using tone code or speech (model -S).

⚠ In case the selected option is *off* and a telephone report is being acknowledged by a call back (only if this is set with the relevant telephone number), the Octalarm answers after 2 rings.

⚠ In case the selected option is *on*, retrieving the alarm status is always possible, even when the telephone dialler key is switched off.

ANSWER AFTER: 05 CALL SIGNALS

Use this option to set the number of call signals (1 to 19) that the Octalarm should wait before answering to send on the alarm status.

⚠ Make sure that the MSN number is entered correctly, without prefix. If the MSN number is not correct, the Octalarm will not answer. If no MSN number has been entered, the Octalarm will respond to every incoming call after the set number of call signals.

Telephone line test: on / off

The default setting for telephone line testing is *on*. If the telephone connection is lost, the warning light and the buzzer will come on. You can turn this setting off if the telephone line test alarm regularly comes on if another telephone connected to the same line is used. (Combinations of the Octalarm with some home or professional switchboards and some telephones may cause problems.)

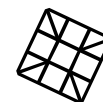

18.6.3 Octalarm for GSM (mobile communication network)

The following options are available:

Report delay: 00MIN

Use this option to set the delay in minutes (from 0 to 99 min). The alarm will not be sent until the set time has passed.

Auto answer: off / on

Use this option to allow remote access to the alarm status:

- OFF the Octalarm will not answer calls to the machine,
- ON the Octalarm will answer after a set number of call signals (see below) and will pass on the status of the alarm channels, using tone code or speech (model -S).
- If the setting is off and a telephonic alarm is followed by a dial-back to confirm the alarm (if this option has been selected for this telephone number), the Octalarm will nevertheless answer.

 If this option is set to on, it is always possible to access the alarm status, even if the telephone dialler button has been switched off.

SMS central number:

To send SMS messages, Octalarm needs the so-called SMS central number. This number is provided by the network operator or service provider when you take out your subscription. Enter that number here.

Set GSM PIN code yes / no

If you wish to enter the PIN code of your SIM card, select yes.

 You cannot change the PIN code of your SIM card using the Octalarm. If you so wish, you can change the code by temporarily placing the SIM card in a standard mobile telephone, changing the code, replacing the SIM card in the Octalarm and entering the new code.

GSM unblocking code:

If your SIM card has been blocked because an incorrect PIN code was entered, the Octalarm will ask this question. Enter the unblocking code provided with your SIM card. Remember to enter the correct PIN code afterwards!

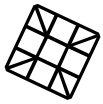

18.7 Prog 42 “set dial sequence”

Within this program, the order of the call numbers to be dialled for the connected alarm channels and for the "mains failure" and "battery empty" channels can be re-assigned. This is done using two alarm entries on the Octalarm-T16. Alarm entries 1 and 2 are connected to the same channel internally, etc.

The following options are available for each single channel:

ALARM CHANNEL 1: ALL NUMBERS / OFF / SELECTIVE DIAL

Select the desired telephone report order as follows:

- **OFF**: the alarm concerned is not reported by telephone, but locally by the alarm buzzer.
- **ALL NUMBERS**: the dialling starts with the call number set first (usually number A). In case this report fails, the Octalarm will attempt to call the next number set. All defined numbers will pass in alphabetical order from A through J, whereby a blank number will be skipped automatically. If, for instance, 4 numbers are set, these numbers are dialled alternately until the reset procedure is passed through correctly. The reporting stops after 15 unsuccessful report attempts.
- **SELECTIVE DIAL**: makes a selection from the call numbers A through J for each single alarm channel possible. Compilation of reporting groups is possible as well, whereby a reset by telephone must be received from each reporting group before the reporting ceases. With this option, the following question appears:

REPORT TO:

Enter the numbers to call using the cursor keys. The numbers defined are dialled alternately until the reset procedure is passed through correctly. The reporting stops after 15 unsuccessful report attempts.

Creating reporting groups is possible as well. The call numbers belonging to one group are entered immediately after one another. Groups of call numbers are divided by a "+" sign. In an alarm situation, a report will be sent at first to the first group. After one of the call numbers resets the report by telephone, a new report cycle to the next reporting group is initiated.

Examples:

- **A**: report only to call number A. The reporting is stopped after a reset by telephone or 15 unsuccessful report attempts.
- **AB**: report to call number A and, in case no reset is given, followed by report to B. If again no reset follows, back to A, etc. Reporting to these numbers is stopped if one of the two numbers gives a reset by telephone or after 15 unsuccessful report attempts.
- **AAAAB**: 4 report attempts to call number A and only then an attempt to call B. The reporting stops after 15 unsuccessful report attempts, the cycle AAAAB will also be repeated 3 times if necessary.
- **A+B**: reporting is limited to call number A exclusively. After a reset by telephone or after 15 unsuccessful report attempts, a second complete reporting cycle to call number B will still be started. Also, both call numbers have to acknowledge the reception of the report.
- **ADCB+EG**: reporting is carried out to the group of call numbers existing of A, D, C or B and to the group of call numbers existing of E or G. The dialling order in a group is determined by the order of the characters. The reporting to the first group is stopped if the report is reset by telephone by one of the numbers A, D, C or B. Now, the report is sent to the second group, until one of these numbers called gives a reset by telephone as well. For each individual group, 15 report attempts are carried out at most.

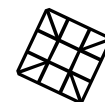

- ⚠ Changes of the dialling order are to be handled carefully, because in case of a wrong set-up, it is possible that an alarm will no longer be reported! Therefore, always check if the numbers entered (A-J) at the dialling order that have actually been entered are a call number (see: part 7 “SET”).
- ⚠ In case more than one reporting group is set and no reset is given by the first reporting group, it can take a long time (the time needed to carry out 15 reports, plus the delay times set with them) before the second reporting group will be called.
- ⚠ Changes of the dialling order can lead to an alteration of the order in which simultaneously occurring alarms are reported. See for the regarding effects: paragraph 4.5 “More than one alarm simultaneously”.

AUTOMATIC REPEAT: YES / NO

Define whether an automatic repeat of a telephone alarm is desired.

- NO the telephone report will be carried out only once, following the dialling order set with the reporting channel.
- YES the telephone report will be started again according to the dialling order set with the alarm channel after a waiting time, irrespective of a former reset by telephone. The repeating report will cease only if the alarm expires (alarm indicator off) or when the relevant selection key on the Octalarm is switched off. The automatic repeating will be finished after 24 hours.

AUT. REPEAT AFTER: 01:00 (HRS:MIN)

Set the waiting time for repeating telephone alarm here.

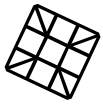

18.8 Prog 55 “set pager codes”

Setting an individual report code for each alarm channel and for all pager types is possible. The following report codes are already pre-programmed:

channel	tone-only pagers	numerical pagers	alpha-numerical pagers and SMS-messages
alarm 1	1	1	alarm 1
alarm 2	2	2	alarm 2
alarm 3	3	3	alarm 3
alarm 4	4	4	alarm 4
alarm 5	1	5	alarm 5
alarm 6	2	6	alarm 6
alarm 7	3	7	alarm 7
alarm 8	4	8	alarm 8
alarm 9	1	9	alarm 9
alarm 10	2	10	alarm 10
alarm 11	3	11	alarm 11
alarm 12	4	12	alarm 12
alarm 13	1	13	alarm 13
alarm 14	2	14	alarm 14
alarm 15	3	15	alarm 15
alarm 16	4	16	alarm 16
mains failure	4	9 or 90 (OT16)	mains failure
battery empty	4	10 or 91 (OT16)	battery empty / failure

18.8.1 Set report codes tone-only pager

Select the option:

SET REPORT CODES TONE-ONLY PAGER.

After the Prog-key is pressed, the following appears:

ALARMCHANNEL 1: 1

Here, enter the code (1 through 8) to appear on the pager in case alarm channel 1 is activated.

 When using the report codes 5 to 8, it must be checked if the pager can actually receive these codes. Tone-only pagers are in fact supplied for 4 as well as for 8 report codes.

18.8.2 Set report codes numerical pager

Select the option:

SET REPORT CODES NUMERICAL PAGER.

After the Prog-key is pressed, the following appears:

ALARMCHANNEL 1: 1

Here, you enter the code to appear on the display of the numerical pager in case alarm channel 1 is activated. The maximum number of digits to be set is 14.

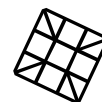

⚠ Consider the PIN-code when using a PIN-code pager (see paragraph 7.2 “Report to a pager”), because during a report, it is part of the report code. The sum of “PIN-code + report code” must not exceed 14 characters. The Octalarm will not send the surplus of characters.

18.8.3 Set codes of alpha-numerical pager and SMS-messages

Select the option:

SET REPORT ALPHANUM PAGER

After the Prog-key is pressed, the following appears:

ALARM CHANNEL 1: ALARM 1

Here you enter the message, which has to appear on the display of the alpha-numerical pager in case alarm channel 1 is activated. Entering up to 40 characters is possible.

With the Octalarm-T16, the following will first appear:

Opening message: opening message

This message will be sent prior to the message set for the alarm channel in question. The opening message can be used for such things as sending a location name.

18.9 Prog 59 “record voice messages”

This program is only available in case the Octalarm is equipped with a voice processor (version -S).

Record an individual message for every connected alarm channel and for the alarms “mains failure” and “battery empty” as well. With the Octalarm-T16, also speak in the opening message. This message will be sent prior to the message set for the alarm channel in question. The opening message can be used for such things as sending a location name.

A spoken message will be shown by the telephone if the alarm in question is sent, or if the alarm is called up by telephone.

RECORD/PLAYBACK ALARM CHANNEL 1

Select the number of an alarm channel in order to record or play back a message.

⬆ START RECORD

⬇ START PLAYBACK

Select playback or recording using the ⬆ or ⬇ key. In case `start record` is selected, the recording starts immediately. Speak clearly into the built-in microphone from a distance of approximately 20 cm. The microphone is situated at the bottom right in the frame of the bottom, near the reset key.

The recorded message can be checked using the built-in speaker with `playback`.

⚠ In case no message is recorded, the telephone report and the alarm reproduction retrieved by telephone take place through tone codes.

18.10 Prog 61 “set access code”

A number of functions can be protected by means of one shared 4-digit access code. Select whether the function concerned has to be protected by this access code.

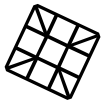
**KEYBOARD ACCESS: WITHOUT CODE / WITH CODE**

Select whether the entire operation of the Octalarm has to be protected by an access code.

PROGRAMMING: WITHOUT CODE / WITH CODE

Select whether programming the Octalarm has to be protected by an access code. The setting "with code" only protects the use of the cursor keys, the Prog-key and the esc-key. The remaining keys can be operated in the usual way.

REMOTE SWITCHING: WITHOUT CODE / WITH CODE

Select whether entering an access code, in order to switch a relay output by telephone, is required.

REMOTE PROGRAM: INHIBITED / WITH CODE

Select whether programming the Octalarm at a distance through the telephone line using a PC and a modem is desired:

- INHIBITED programming at a distance is not possible.
- WITH CODE programming from distance is only possible after the access code is entered.

ACCESS CODE: 0000

Enter the 4-digit access code here.

 Programming from a distance without the use of an access code is never possible.

18.11 Prog 71 "set night time mode"

Here you can define in what way the alarm report has to be carried out when the Octalarm functions in night time mode.

AL BUZZER NIGHT: OFF / ON

Define whether the use of the internal and external alarm buzzers is desirable in case of a local alert at night. If so, the following options appear:

ALARM BUZZER ON: DIRECT AT ALARM / DIALLING FAILURE / AFTER DELAY

Set the start condition for the alarm buzzer:

 **DIRECT AT ALARM** the alarm buzzer sounds immediately after the detection of the alarm.

 **DIALLING FAILURE** the alarm buzzer only sounds after the complete failure of a telephone report and also after 15 failing dialling attempts. The alarm buzzer will however sound immediately in case the telephone dialler key is switched off.

 **AFTER DELAY** the alarm buzzer only sounds after the set delay time has elapsed. With this option, the following additional question appears:

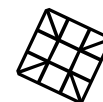

DELAY TIME: 01 MIN

Here you can enter the desired delay time (from 1 to 99 min).

In case of a switched on alarm buzzer, the following question is asked:

ALARM BUZZER OFF: AFTER TEL RESET / BY RESET KEY / AFTER DELAY

Set the stop condition for the alarm buzzer:

- AFTER TEL RESET the alarm buzzer is switched off after a successful telephone report. The buzzer keeps sounding after 15 failed report attempts. If the telephone dialler key is switched off, the alarm buzzer will sound until the reset key is pressed.
- BY RESET KEY the alarm buzzer only stops after pressing the reset key.
- AFTER DELAY the alarm buzzer stops automatically after the set delay time has elapsed. With this option, the following additional question appears:

DELAY TIME: 01 MIN

Set the desired delay time here (from 1 to 99 min).

VOLUME INTERNAL BUZZER: 2

Select the desired volume for the built-in buzzer. The Octalarm allows you to hear the chosen volume during programming.

NIGHT TO DAY: ALARM BUZZER ON / ALARM BUZZER OFF

Here you can define whether the buzzer key has to be switched on or off when the night time mode is disabled.

DIALLER NIGHT: OFF / ON

Define whether a telephone report at night is desirable. If so, the following question appears:

DIALLER DELAY: 00 MIN.

Here you can enter the desired delay time (from 1 to 99 min).

NIGHT TO DAY: DIALLER ON / DIALLER OFF

Here you can define here whether the telephone dialler key has to be switched on or off when the night time mode is disabled.

KEYBOARD INHIBIT AT NIGHT: NO / YES

In case yes is chosen, all keys on the operation panel will be locked, irrespective of the keyboard access being protected with an access code or not.

18.12 Prog 95 “sensor test”

This program enables the one- by- one testing of the Sensornet terminal blocks. If the Octalarm recognizes the sensor, this will be reproduced on the display.

 Take care to ensure that the Octalarm always "sees" only one sensor connected at the same time, otherwise the message `SENSOR DEFECTIVE` appears. If necessary, disconnect Sensornet from the Sensornet input and connect the block to test it directly to the input.

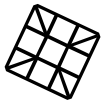

18.13 Prog 97 “read data log”

The data log stores the most important alarm reports and/or program modifications in a permanent memory. About 50 incidents with a time reference are stored together.

The data log uses a continuously working counter as a time reference. With each registration, the corresponding counter reading is stored as well. If you subtract this time from the actual logging time, you are able to find out exactly how long ago a certain incident took place. The time reference runs until 1.000 hours at maximum, after which it is restarted at time 0 again. Reports older than 1.000 hours will be removed.

The following messages can occur in the data log:

General:

LOG TIME xxx x

The actual log reference time in hours and minutes. When you read out the data log, this is the first message to appear.

000:00 OCTALARM STARTED

The Octalarm had a complete restart. The time has been reset to 000:00 by this.

Program modifications:

xxx:xx CALL NR. A: CHANGED

The call number (A) shown is changed on time xxx:xx.

xxx:xx PROG zz CHANGED

Program zz is changed on time xxx:xx. In case this regards Prog. 42 (dial sequence), the alarm channel of which the order has been changed is indicated as well.

xxx:xx SELECTION: 1--567- T Z

At time xxx:xx, the position of the selection keys has been changed. In this example, the alarm selection keys 1,5,6,7 and the telephone dialler and buzzer key are switched on, the remaining selection keys are off. To prevent a message arising in the log with every key touch (by which the log would quickly be full), the final position of the selection keys is only stored 5 minutes after the last key touch.

Alarm reports:

xxx:xx MAINS FAILURE

xxx:xx BATTERY EMPTY

xxx:xx TEL FAILURE

xxx:xx ALARM 1

At time xxx:xx, respectively a mains failure, a battery empty alarm, a telephone line malfunctioning or an alarm 1 (external) has taken place. If the relevant selection key was switched off at the time of an external alarm, SEL .KEY OFF appears on the display as well. In case the telephone dialler key was switched off at the time of an alarm, also tel . dial l er off . appears on the display. If the alarm channel is turned off in mб, ALARM XOFF IN DIALSEQ. appears on the display.

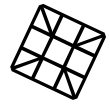
**Report sequence:**

XX: XX ALARM 1 ACCEPTED A:

XX: XX ALARM 1 FAILED

XX: XX MANUAL RESET

xxx:xx ALARM 1 EXPIRED

At time xxx:xx ,respectively the report of alarm 1 is accepted by call number A, the report of alarm 1 has been stopped after 15 unsuccessful reporting attempts, the Octalarm is reset manually or alarm 1 has expired.

18.14 Prog 98 “choose language”

Choose between the languages “Dutch”, “German”, “French” or “English”. From now on, all messages except self-defined will appear on display in the chosen language.

18.15 Prog 99 “clear all settings”

By erasing all the settings, the Octalarm will function according to the factory defaults again. Due to protection, the question will be asked twice.

 ALL telephone numbers entered, ALL modifications of the installation data and ALL recorded voice messages (for version -S) will be erased.

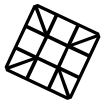

19. TECHNICAL SPECIFICATIONS

Number of inputs	2, 4, 8 or 16
Input contacts:	normally open or normally closed, potential-free, contact power 1mA, open charge 5V.
Amount of call numbers:	10, at max. 16 digits per number
Dialling default analogue:	tone code or pulse code
Dialling default ISDN	Euro ISDN (<i>model-I</i>)
Mobile network	900 / 1800Mhz (<i>model-G</i>)
Outputs:	open-collector, max. 150mA, with shared power supply 10 to 15Vdc (nominal 12Vdc), short-circuit protected
RS-232 port:	25-pole female sub-D, connections in accordance with standard DCE, at which connected:
	signal pin input/output
	RXD 2 input
	TXD 3 output
	RTS 4 input
	CTS 5 output
	DSR 6 output
	GND 7 -
	CD 8 output
	DTR 20 input
	RI 22 output
Baud rate:	19.200 baud,
Power supply:	205-245Vac, 50-60Hz
Power consumption:	4-9 Watt
Emergency power supply:	maintenance- free lead battery 12V/ 1.2Ah
Back up emergency power supply:	3.5 up to 15 hours, dependent on the externally connected alarm devices
Length of power cable:	approx. 1.7 m
Length of telephone cable:	approx. 2 m
Size:	255 x 171 x 58 mm
Weight:	1.9 kg
Max. temperature for usage:	-5 to +50 C

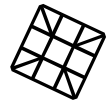

Call numbers:

	report to:						number	reset			reset code	delay time
	telephone	tone-only pager	(alpha) numerical pager	mobile voice / tone	mobile SMS	reporting service		by call back	during report	by report service		
A:												
B:												
C:												
D:												
E:												
F:												
G:												
H:												
I:												
J:												

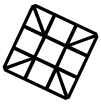

Installation programs

Prog 10: set display contrast

Prog 11: show version number

Prog 21: set alarm inputs

	open (NO)	closed (NC)	direct	via sensornet	alarm delay	with memory	reset if successful
input 1					: min		
input 2					: min		
input 3					: min		
input 4					: min		
input 5					: min		
input 6					: min		
input 7					: min		
input 8					: min		

	open (NO)	closed (NC)	alarm delay	with memory	reset if successful
input 9			: min		
input 10			: min		
input 11			: min		
input 12			: min		
input 13			: min		
input 14			: min		
input 15			: min		
input 16			: min		
batt. empty			: min		
mains failure			: min		

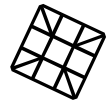

Prog 23: set alarm in display

	display text
channel 1	
channel 2	
channel 3	
channel 4	
channel 5	
channel 6	
channel 7	
channel 8	

	display text
channel 9	
channel 10	
channel 11	
channel 12	
channel 13	
channel 14	
channel 15	
channel 16	

Prog 31: set alarm buzzer

alarm buzzer on direct at alarm
 if dialling fails
 after delay
 min

volume internal buzzer

alarm buzzer off after tel. reset
 by reset key
 after delay
 min

Prog 41: set dialler (analogue model)

report delay min

auto answer off
 on
 after rings

dial mode tone (dtmf)
 pulse (dtmf)

wait for first dialling tone yes
 no

telephone line test on
 off

Prog 41: set dialler (ISDN model)

report delay min

MSN number (without prefix)

CLIP number (without prefix)

auto answer off
 on
 after rings

telephone line test on
 off

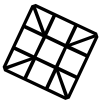

Prog 41: set dialler (GSM model)

alarm delay min

auto answer off
 on

SMS central number

PIN code

PUK code (unblocking)

Prog 42: set dial sequence

	report			to	repeat	
	all numbers	off	selective		automatic	time (hrs:min)
input 1	<input type="checkbox"/>	<input type="checkbox"/>	<input type="checkbox"/>	<input type="text"/>	<input type="checkbox"/>	:
input 2	<input type="checkbox"/>	<input type="checkbox"/>	<input type="checkbox"/>	<input type="text"/>	<input type="checkbox"/>	:
input 3	<input type="checkbox"/>	<input type="checkbox"/>	<input type="checkbox"/>	<input type="text"/>	<input type="checkbox"/>	:
input 4	<input type="checkbox"/>	<input type="checkbox"/>	<input type="checkbox"/>	<input type="text"/>	<input type="checkbox"/>	:
input 5	<input type="checkbox"/>	<input type="checkbox"/>	<input type="checkbox"/>	<input type="text"/>	<input type="checkbox"/>	:
input 6	<input type="checkbox"/>	<input type="checkbox"/>	<input type="checkbox"/>	<input type="text"/>	<input type="checkbox"/>	:
input 7	<input type="checkbox"/>	<input type="checkbox"/>	<input type="checkbox"/>	<input type="text"/>	<input type="checkbox"/>	:
input 8	<input type="checkbox"/>	<input type="checkbox"/>	<input type="checkbox"/>	<input type="text"/>	<input type="checkbox"/>	:

	report			to	repeat	
	all numbers	off	selective		automatic	time (hrs:min)
input 9+10	<input type="checkbox"/>	<input type="checkbox"/>	<input type="checkbox"/>	<input type="text"/>	<input type="checkbox"/>	:
input 11+12	<input type="checkbox"/>	<input type="checkbox"/>	<input type="checkbox"/>	<input type="text"/>	<input type="checkbox"/>	:
input 13+14	<input type="checkbox"/>	<input type="checkbox"/>	<input type="checkbox"/>	<input type="text"/>	<input type="checkbox"/>	:
input 15+16	<input type="checkbox"/>	<input type="checkbox"/>	<input type="checkbox"/>	<input type="text"/>	<input type="checkbox"/>	:
battery empty	<input type="checkbox"/>	<input type="checkbox"/>	<input type="checkbox"/>	<input type="text"/>	<input type="checkbox"/>	:
mains failure	<input type="checkbox"/>	<input type="checkbox"/>	<input type="checkbox"/>	<input type="text"/>	<input type="checkbox"/>	:

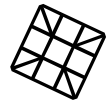
**Prog 55: set pager codes**

	tone-only pagers	numerical pagers	alpha-numerical pagers en SMS-messages
channel 1			
channel 2			
channel 3			
channel 4			
channel 5			
channel 6			
channel 7			
channel 8			
channel 9			
channel 10			
channel 11			
channel 12			
channel 13			
channel 14			
channel 15			
channel 16			
mains failure			
batt. empty / defect			
main message			

Prog 59: record voice messages

	recorded text
channel 1	
channel 2	
channel 3	
channel 4	
channel 5	
channel 6	
channel 7	
channel 8	

	recorded text
channel 10	
channel 11	
channel 12	
channel 13	
channel 14	
channel 15	
channel 16	
mains failure	
batt. empty / defect	
main message	

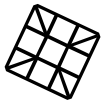

Prog 61: set access code

<input type="text" value="service"/>	<input type="checkbox"/> without code	<input type="text" value="remote switching"/>	<input type="checkbox"/> without code
	<input type="checkbox"/> with code		<input type="checkbox"/> with code
<input type="text" value="program"/>	<input type="checkbox"/> without code	<input type="text" value="remote programming"/>	<input type="checkbox"/> blocked
	<input type="checkbox"/> with code		<input type="checkbox"/> with code

Prog 71: set night time mode

<input type="text" value="alarm buzzer night"/>	<input type="checkbox"/> off	<input type="text" value="volume internal buzzer"/>	<input type="text"/>
	<input type="checkbox"/> on	<input type="text" value="night to day"/>	<input type="checkbox"/> alarm buzzer on
<input type="text" value="alarm buzzer night on"/>	<input type="checkbox"/> direct at alarm		<input type="checkbox"/> alarm buzzer off
	<input type="checkbox"/> If dialling fails	<input type="text" value="dialling night"/>	<input type="checkbox"/> off
	<input type="checkbox"/> after delay		<input type="checkbox"/> on
	<input type="text" value="min"/>	<input type="text" value="report delay at night"/>	<input type="text" value="min"/>
<input type="text" value="alarm buzzer night off"/>	<input type="checkbox"/> after tel. reset	<input type="text" value="night to day"/>	<input type="checkbox"/> dialler off
	<input type="checkbox"/> by reset key		<input type="checkbox"/> dialler on
	<input type="checkbox"/> after delay	<input type="text" value="keys blocked at night"/>	<input type="checkbox"/> no
	<input type="text" value="min"/>		<input type="checkbox"/> yes

Prog 95: sensor test

Prog 97: read data log

Prog 98: choose language

Prog 99: clear all settings

